

Remote Control of Experiments (RCE)(202100225)

Information session

Jeroen W.J. Verschuur

University of Twente

December 11th; 2023

- 1 Introduction
- 2 Content of the course
- 3 Beckhoff Topology
 - Remote sytem: CX7000
- 4 NI topology
 - Remote system: cRIO
- 5 Device interfacing and device design
 - Computer Interfacing with DAQmx and commercial instruments
 - Sensors & Actuators
- 6 Example
- 7 Final Assignment
- 8 Learning outcomes, Grading and Scheduling
 - Learning outcomes
 - Scheduling & Grading
- 9 Warning!
 - Disclaimer
- 10 end

Motivation

- Modern techniques for an engineer: Control of distributed systems by computer.
- Already an old idea.
- Re-inspired by the Covid-19-virus measures: Remote work.
- Implemented in own experiments in the SLT-laboratories.
- Experimental counterpart of Computational Physics.

Elements in the course I

- Structures and approaches
 - Architectures for measurement and control.
 - Different demands \leftrightarrow Different approaches.
 - Research versus industry.
- Beckhoff: Control & Monitoring
 - Industry standard – PLC structure.
 - Distributed system – bus/ethernet, local stations, dedicated modules.
 - TwinCAT3: programming and control software.
- NI: Measurement & Control
 - Distributed system – Ethernet, local embedded systems, dedicated modules.
 - LabVIEW programming – transparent over distributed system.
 - G-web server: access via Internet browser.

Elements in the course II

- Direct device control and custom-device design
 - Direct control of devices: VISA (Virtual Instrument Software Architecture) an IVI (Interchangeable Virtual Instrument) standard.
 - Communication with commercial instruments: USB, GPIB-bus, RS232.
 - PC-interfacing e.g. DAQmx.
 - Micro-controllers: custom devices.
 - Smart sensors: PMod modules.
 - Bus-structures and protocols for sensors: i^2C , SPI, UART
- Integrated design & realisation showcase:
 - Design your own Measurement & Control or Control & Monitoring system.
 - Realize your system in hardware and software.
 - Demonstrate your system.
 - Reflect on the performance verses the design specifications.

Beckhoff topology

Movable objects

Management level



Field/Control level

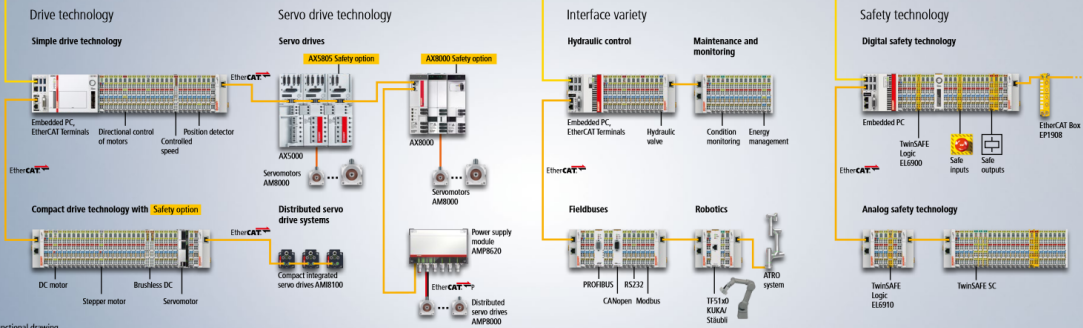

Technical functional drawing

NI topology

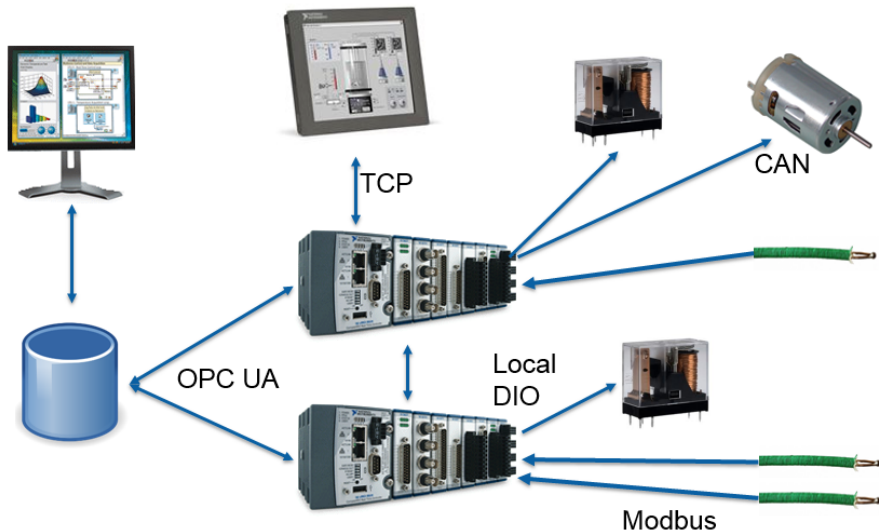

What will you learn?

- Topology of Control & Monitoring and Measurement & Control systems
- TwinCAT programming
- LabVIEW programming including G-web programming
- Design of C&M and M&C systems
- Device control via PC
- Device design with micro-controllers and smart sensors
- Design, realize and commission a distributed C&M or M&C system

Course time-line with subjects

week	subject	programming	elements
1	Beckhoff structure	TwinCAT 3	embedded PC; fieldbus systems
2	NI structure	LabVIEW + G-web	programming language
3			addressing IO
4			cRIO including modules
5			Device control
6	Device design	Python & pyVISA	i ² C-bus; SPPI-bus; smart sensors; Pmod
7	Own design	–	<i>minimal requirements</i>
8-9	Realize & test		Build
10	Presentation		Commissioning

The Beckhoff CX700 + fieldbus modules



The cRIO system

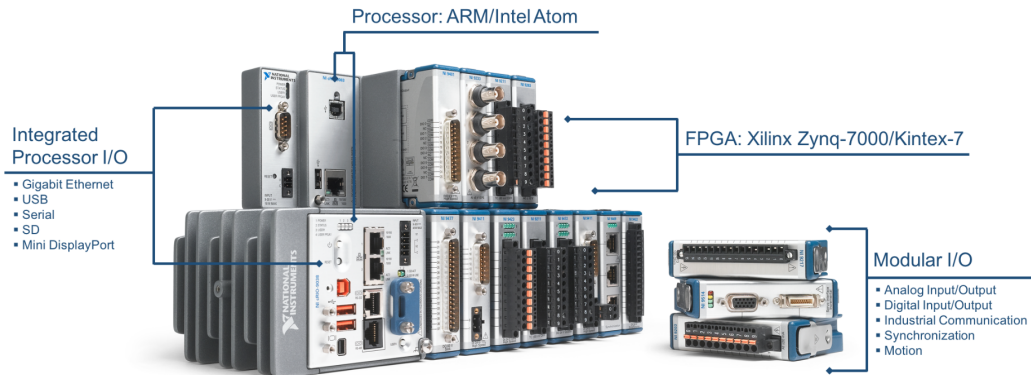

Figure: The cRIO system.

Device interfacing

- Introduction DAC, ADC and DIO.
- Introduction device control via: USB, GPIB, RS232.
- Automation of a measurement protocol.
- Explore and test the limits of the interface hardware – software
 - timing
 - resolution
 - control
 - data handling

Device design

- Use of micro-controller as a measurement device
- Use of bus-structures and protocols: i²C and SPI
- Realise a simple data-logger with remote readout.
- Explore the limits of the system:
 - Timing and speed issues
 - Resolution
 - Controllability



Pmod AD2: 4-channel 12-bit
A/D Converter
\$18.99

ADD TO CART



Pmod ACL: 3-axis
Accelerometer
\$14.99
★★★★★

ADD TO CART



Pmod GYRO: 3-axis Digital
Gyroscope
\$19.99

ADD TO CART



Pmod TMP3: Digital
Temperature Sensor
\$6.99
★★★★★

ADD TO CART



Pmod RTCC: Real-time Clock /
Calendar
\$8.99

ADD TO CART

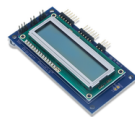

Pmod CLS: Character LCD with
Serial Interface
\$29.99

ADD TO CART



Pmod TMP2: Temperature
Sensor
\$14.99
★★★★★

ADD TO CART



Pmod IA: Impedance Analyzer
\$38.99

ADD TO CART



Pmod AMP3: Stereo Power
Amplifier
\$9.99

ADD TO CART



Pmod PMON1: Power Monitor
\$9.99

ADD TO CART



Pmod HYGRO: Digital Humidity
and Temperature Sensor
\$14.99

ADD TO CART



Pmod CDC1: Capacitive Input
Buttons
\$7.99

ADD TO CART



Pmod IOXP: I/O Expansion



Pmod CMP52: 3-Axis Compass



Pmod COLOR: Color Sensor



Pmod HAT Adapter: Pmod

Device design with smart sensors

- Explore smart-sensor modules: Pmod
- Explore communication protocols between micro-controller and Pmod's
- Realize a simple Pmod project
- Make a custom device with a micro-controller
- Explore the limits of the system
 - Timing and speed issues
 - Resolution
 - Controllability

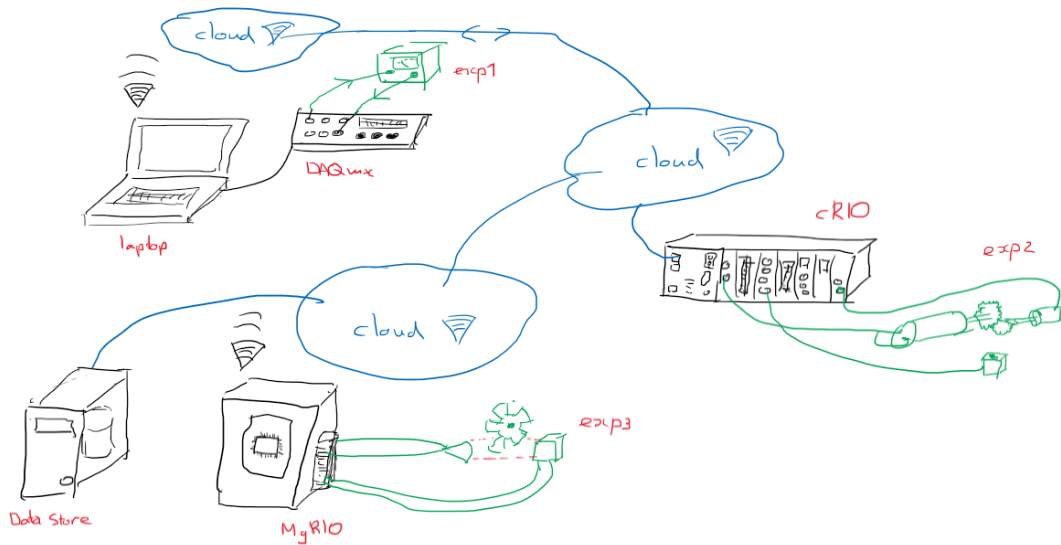
Schematic Measurement & Control configuration

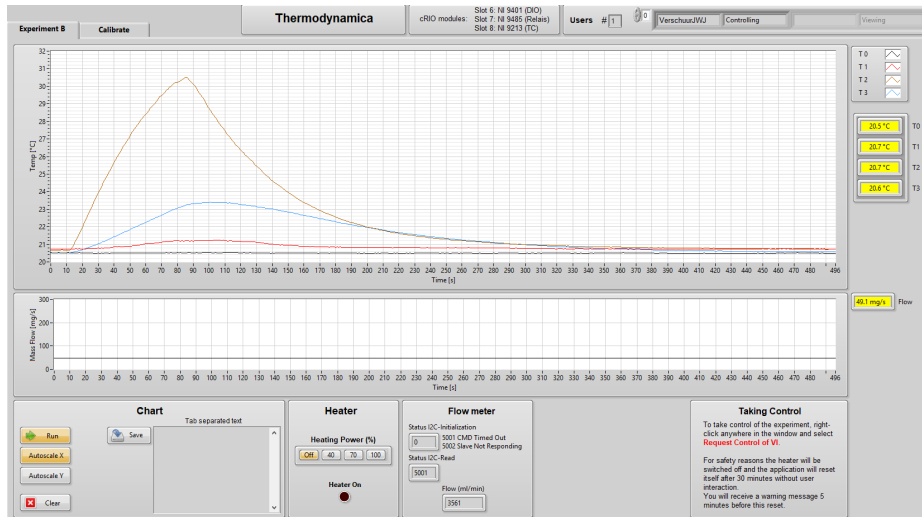

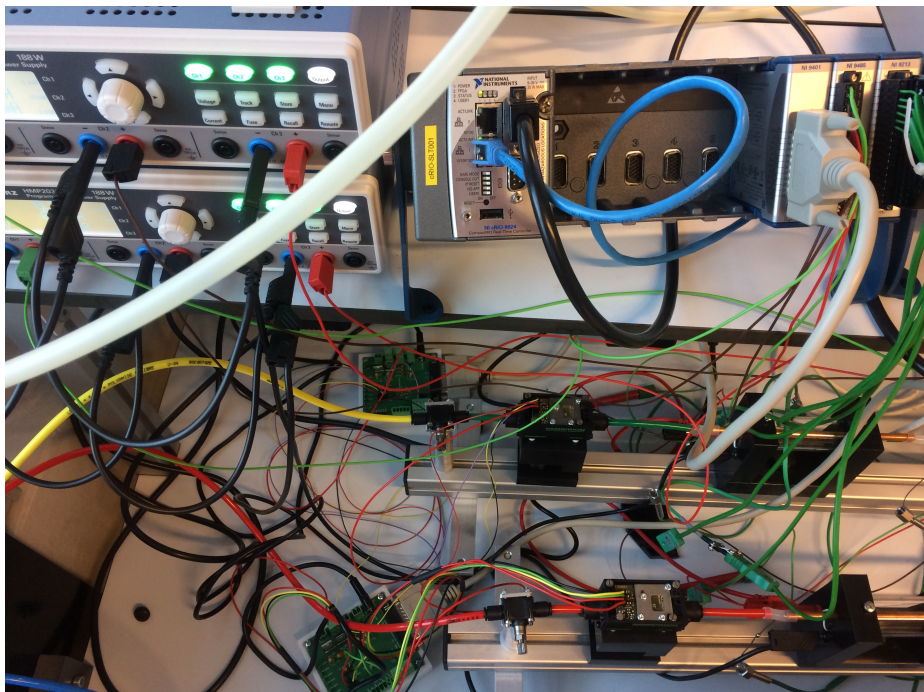

Final Assignment

The final assignment:

- Project based structure: Engineering project.
- You can co-design your own final assignment.
- Combination with work for your Bachelor assignment is possible.
- It is an engineering project:
 - Loop through: explore – design – build – test
 - The outcome is a product:
 - it works
 - it meets criteria
 - it fulfils a purpose
 - it is more than a proof of principle

Learning outcomes

Computer as tool:

- Control of laboratory equipment: local and remote.
- Computer interfacing with experiments for measurements (automation).
- Analysis and presentation of measurement data.
- Set up measurement-control-steer loops.

Programming environment TwinCAT, LabVIEW, Python:

- PLC-programming – sequential tasks and actions.
- Graphical programming – diffusing the hardware–software interface.
- Design and realise a functional user interface to control an experiment; also remote.
- Topology, communication & synchronisation of processes.
- Set-up distributed control & measurement structures.

Engineering:

- Design a remote/distributed measurement-control or control-monitor system.
- Realise the system using the appropriate hardware and software.
- Test the system, make a performance report and compare with the design criteria.

Scheduling & Grading

Scheduling:

- Scheduling: see course time-line (above).

Grading:

- Compact journal of the guided-tour problems.
- A design report.
- A working system.
- A performance report.
- A manual (optional).
- Presentation and discussion of the work and results.

Disclaimer

This course is as perfect as YOU make it!

Note that:

- This is the first time this course is part of the Applied Physics program.
- It is still under development.
- It is not yet tested.
- So ...
 - If you expect a well balanced course: *this is not for you!*
 - If you like to explore new fields: *this is your chance!*
 - If you did not like module 5: *this is not for you!*
 - If you did like module 5: *this is where you can take control!*

end