

# Dynamics of Machines

## Introduction SPACAR

Lecturer: Ronald Aarts  
University of Twente / Faculty of Engineering Technology (CTW)  
Mechanical Automation (Wa)  
Horstring (building 21) Z 229  
Phone: (053) 489 2557 / 2502  
Email: R.G.K.M.Aarts@utwente.nl

WWW: Link on <http://www.wa.ctw.utwente.nl/software/spacar/>

## Part 1: Getting started (1)

- Download the software and examples from our web site. Two parts:
  - The SPACAR GUI to create models (Microsoft Windows).
    - Unpack ZIP-file anywhere on your PC's harddisk.
    - On-line help.
    - Built-in update manager.
    - License until March 31, 2015.
  - The SPACAR toolbox for MATLAB/SIMULINK (32-bit/64-bit MS Windows\* only).
    - Follow the installation instructions.
    - Launch MATLAB and extend the path (preferably permanently).
    - Additional help and demo's available.
    - License until March 31, 2015.

\* Note the information about possibly missing files.

## Part 1: Getting started (2)

- Using the SPACAR GUI:
  - Run `spacar20.exe`
  - Build your model (\*.spa file), create \*.dat file and launch MATLAB.
- The SPACAR toolbox for MATLAB/SIMULINK:
  - Input is \*.dat file, either from the GUI or created manually with your favourite text editor.
  - Run the `spacar(...)` command.
  - Output are MATLAB variables (also stored in data files) to be investigated with your own tools or e.g. `spavisual`.
- The “manual” section on the web site includes:
  - A guide on “Prototype modelling of mechanical systems”
  - The manual of the SPACAR toolbox.

## Mass-spring model

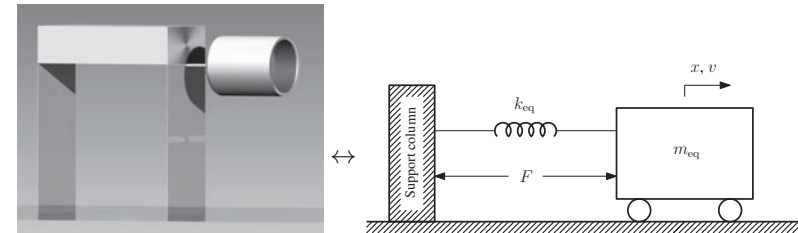

- Model system as a simple one degree-of-freedom mass-spring system.
- All mass is lumped in a single equivalent mass  $m_{eq}$  and the equivalent stiffness  $k_{eq}$  represents all elastic components.
- Input VCM force  $F$  and output position  $x$ :

$$G(s) = \frac{x}{F} = \frac{1}{m_{eq} s^2 + k_{eq}}$$

## First SPACAR model: $x$ degree-of freedom

- The mass-spring system can be modelled as a one-dimensional SPACAR model: Identify elements with their coordinates and deformations.

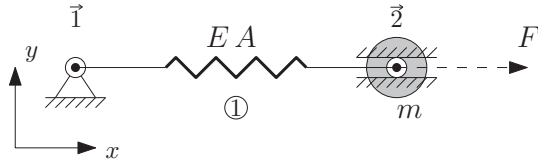

- Two translational nodal points:  $\vec{1}$  and  $\vec{2}$ .
- One element for the spring: a (two-dimensional) *truss* element ①.

## Planar truss element (PLTRUSS)

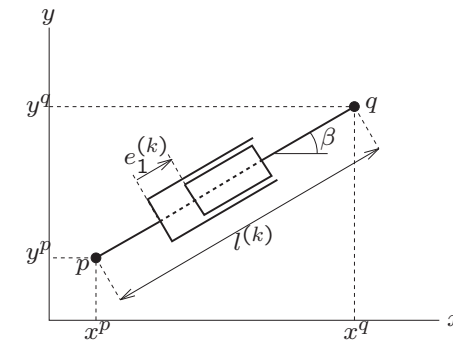

- Two translational nodal points  $p$  and  $q$  with two coordinates each:
 
$$\mathbf{x}_{\text{truss}}^{(k)} = \begin{bmatrix} \mathbf{x}^p \\ \mathbf{x}^q \end{bmatrix} = [x^p, y^p, x^q, y^q]^T.$$
- A single deformation mode  $e_1$  of this element represents the elongation:
 
$$e_1^{(k)} = l^{(k)} - l_0^{(k)}, \text{ with } l^{(k)} = \sqrt{(x^p - x^q)^2 + (y^p - y^q)^2}.$$

## Building model pfl1dtrx.spa – Creating the truss

- Create the truss.
- The end nodes are New
  - specify the (initial) coordinates (0.0, 0.0) and (0.1, 0.0).
- Edit the truss to set its dimensions.

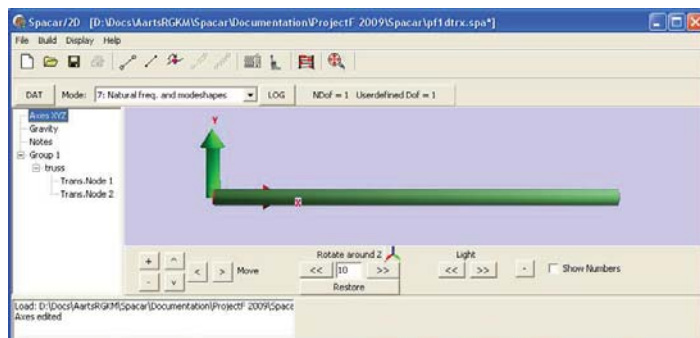
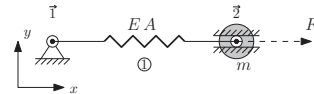

## Building model pfl1dtrx.spa

### – Constraint coordinates and released deformations

- Nodal point coordinates are by default “Dependent”, i.e. can move freely depending on the rest of the system.
  - Set support coordinates to Fixed: Both  $x$  and  $y$  in  $\vec{1}$  and  $y$  in  $\vec{2}$ .

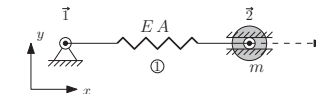

- Element deformations are prescribed zero unless defined otherwise.
  - Set the truss elongation, i.e. deformation  $e_1$ , to Released.

## Building model p1dtrx.spa – Counting the DOF's

- SPACAR computes the number of degrees of freedom NDOF in the system from

$$NDOF = NX - NXO - NEO,$$

$NX = 4$  is the number of nodal coordinates,

$NXO = 3$  the number of *absolute constraints*: Fixed coordinates,

$NEO = 0$  the number of *relative constraints*: The remaining unreleased element deformation parameters.

So  $NDOF = 4 - 3 - 0 = 1$  degree of freedom has to be defined.

- Define e.g. an *absolute degree of freedom*:  
→ Set the  $x$  coordinate of node  $\vec{2}$  to be a Dynamic DOF.
- A *necessary* (though not *sufficient* condition for a valid system definition is that the computed number of DOF's equals the number of DOF's explicitly defined by the user.

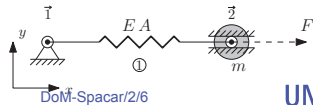

Ronald Aarts

DoM-Spacar/2/6

UNIVERSITY OF TWENTE.

## Building model p1dtrx.spa – Adding mass

- Masses and inertial properties can be specified as a *lumped* mass attached at a nodal point or as a *distributed* mass present along an element.
- Lumped mass and inertia are defined by Editing the nodal point.  
→ Set the Mass of node  $\vec{2}$  to 0.206 kg.
- Distributed mass and inertia (per unit length) are defined by Editing the Mass & Inertia properties of the element.  
→ Set the Mass per Length of the truss element 1 to 0.1413 kg/m (representing both leaf springs).

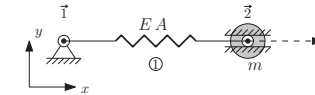

Ronald Aarts

DoM-Spacar/2/7

UNIVERSITY OF TWENTE.

## Building model p1dtrx.spa – Adding stiffness and damping

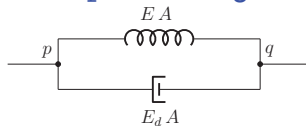

- Edit the Stiffness & Damping properties of the truss to set the axial rigidity  $EA$  and damping  $E_d A$  of the truss element.
- Knowing the equivalent longitudinal stiffness  $k_{eq} = 945 \text{ N/m}$ :  
 $(EA)_{eq} = k_{eq} l_0$ .
- For the considered spring leaves the damping is computed assuming a *relative damping*  $\zeta$  in the range of 0.01 to 0.001 and knowing that the damping  $d_{eq} = 2\zeta \sqrt{k_{eq} m_{eq}}$ .  
Next  $(E_d A)_{eq} = d_{eq} l_0$ .

Ronald Aarts

DoM-Spacar/2/8

UNIVERSITY OF TWENTE.

## Building model p1dtrx.spa – Adding an external force

- Edit a node to define an external force, e.g. a horizontal force of 1 N in node  $\vec{2}$ .

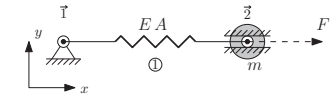

## Building model p1dtrx.spa – Specification of input and output

- Click the Edit additional Dynamic commands button to enter  
INPUTF 1 2 1  
OUTX 1 2 1  
The keywords INPUTF and OUTX define a single input force  $F$  and a single output coordinate  $x$ , respectively.  
The first parameter of both keywords is the input or output number that corresponds with its position in the input vector  $u$  or output vector  $y$ .  
The other two parameters define the input's or output's nodal point number and the corresponding Cartesian nodal coordinate.

Ronald Aarts

DoM-Spacar/2/9

UNIVERSITY OF TWENTE.

## Model pfl1dtrx.spa – SPACAR results

F9: Create dat file and launch MATLAB.

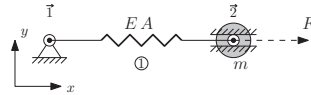

Start SPACAR from the MATLAB command prompt in mode “7”: Static analysis and the computation of the natural frequencies and mode shapes of the system:

```
>> spacar(7, 'pfl1dtrx')
```

Output:

- MATLAB plot window with the system in its equilibrium configuration.
- Log file pfl1dtrx.log.
- Binary data files pfl1dtrx.sbd and pfl1dtrx.sbm.
- MATLAB variables with results read from these files.

## Model pfl1dtrx.spa – SPACAR results (2)

Horizontal displacement of node 2:

```
>> x(lnp(2,1)) = 0.1011
```

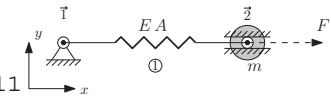

The normal force in the truss element:

```
>> sig(le(1,1)) = 1.0000
```

Mass, stiffness, and (first and only) natural frequency:

```
>> m0 = 0.2107
>> k0 = 945
>> sqrt(eig(k0,m0))/2/pi = 10.6584
```

Visualisation:

```
>> spavisual('pfl1dtrx');
```

## Model pfl1dtrx.dat – SPACAR results (3)

```
>> spacar(9, 'pfl1dtrx')
```

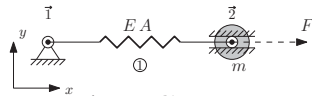

With a mode “9” run the state space matrices  $A$ ,  $B$ ,  $C$ , and  $D$  are computed and stored in binary data file pfl1dtrx.ltv. They can be read with the getss command.

```
>> [A,B,C,D] = getss(pfl1dtrx);
```

```
>> G=tf(getss(pfl1dtrx))
```

Transfer function:

4.746

```
-----
s^2 + 0.1732 s + 4485
```

```
>> bode(G)
```

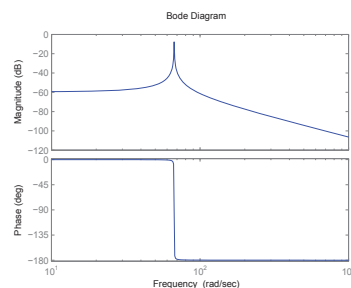

The latter command is used to create a Bode plot.

## Second SPACAR model: $e$ degree-of freedom

Alternatively, a *relative* degree of freedom can be defined by setting a deformation to be a Dynamic DOF.

Of course  $NDOF = NX - NXO - NEO$  has to be satisfied.

- Change `Coordinate` type of the  $x$  coordinate of nodal point  $\vec{2}$  into its default type `Dependent`.
- Change the `Deformation` type of the `Elongation` of the truss element into a `Dynamic` DOF.

Outcome as before ...

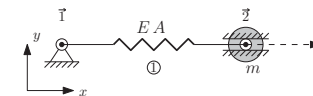

### Two-dimensional model

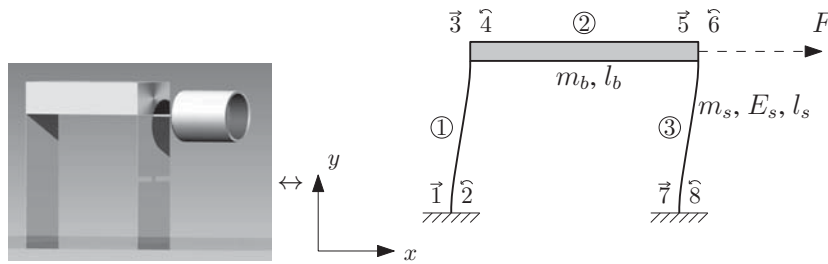

- Bending of the leaf springs modelled more accurately using planar *beam* elements.
- Translational and *rotational* planar nodal points.

### Planar beam element (PLBEAM)

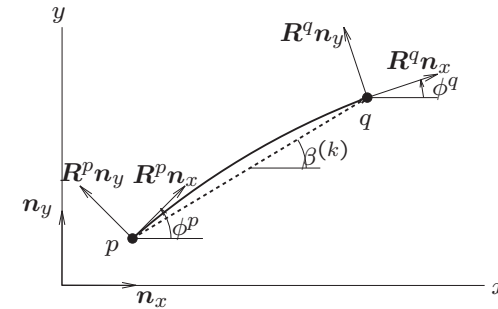

- Four Cartesian coordinates  $(x^p, y^p), (x^q, y^q)$  describing the position of the beam in the  $(x, y)$ -coordinate system.
- Two rotation angles  $\phi^p$  and  $\phi^q$  representing the angular orientation of the triads  $(R^p n_x, R^p n_y)$  and  $(R^q n_x, R^q n_y)$  at the nodes  $p$  and  $q$  respectively.

### Planar beam element (PLBEAM) (2)

Nodal coordinates:  $\mathbf{x}_{\text{beam}}^{(k)} = \begin{bmatrix} x^p \\ \phi^p \\ x^q \\ \phi^q \end{bmatrix} = [x^p, y^p, \phi^p, x^q, y^q, \phi^q]^T$ .

Deformation parameters:

elongation:  $e_1^{(k)} = l^{(k)} - l_0^{(k)}$ ,

bending:  $e_2^{(k)} = -(R^p n_y, l^{(k)})$ ,

$e_3^{(k)} = (R^q n_y, l^{(k)})$ ,

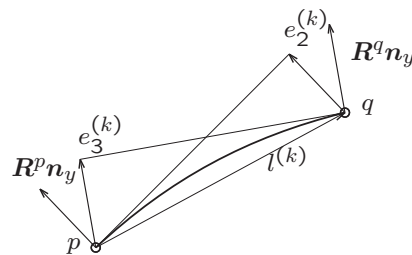

The deformations are independent for rigid body movements of the element and have a clear physical meaning.

### 1-DOF model

Three beams:

- Common nodes  $\rightarrow$  rigid connection.
- Fixed support: Translational nodes 1 and 7, rotational nodes 2 and 8.
- Solid bar: All deformations Zero (default).
- In both leaf springs: Release bending modes  $e_2$  and  $e_3$ .

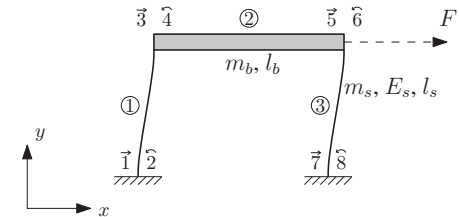

$NDOF = NX - NXO - NEO = 1$  as

$NX = 12$  is the number of nodal coordinates  $(4 \times 2 + 4 \times 1)$ ,

$NXO = 6$  the number of absolute constraints (Fixed  $2 \times 2 + 2 \times 1$ ),

$NEO = 5$  the number of relative constraints, so  $3 \times 3 - 4$

So  $NDOF = 1$ : E.g. horizontal position of node 3.

## 1-DOF model (2)

Distributed inertia of the solid bar ② in a lumped mass representation:

1. The mass of the element should be equal to the sum of the lumped masses.
2. The center of mass of the element and that of the discrete mass model should coincide.
3. The rotational inertia of the element and that of the lumped system should be equal.

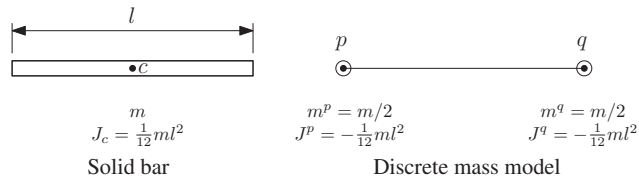

Solid bar with mass  $m$  and length  $l$ : the rotational inertia relative to the centre of mass  $J_c = \frac{1}{12}ml^2$ . Equivalent lumped masses and rotational inertias are then:

$$m^p = m^q = \frac{1}{2}m \quad \text{and} \quad J^p = J^q = -\frac{1}{12}ml^2.$$

## 1-DOF model (3)

- Define lumped and/or distributed masses and inertia properties.
- For the leaf springs it is convenient to use the Calculate Inertia button, provided the beam dimensions and density are defined correctly.
- Define the axial rigidity  $EA$  (related to longitudinal stiffness  $EA/l$ ) and flexural rigidity  $EI$  (related to bending stiffness  $EI/l^3$ ).
- The Calculate button offers a user-friendly automatic calculation of the stiffness properties.
- Damping properties need to be defined manually, see previous model with relative damping  $\zeta$ .

## 1-DOF model (4)

- SPACAR analysis mode 7 and 9 as before: Still 1 natural frequency!
- SPACAR analysis mode 8 for buckling analysis:  
The critical loading parameter  $\lambda_i$  is computed, such that the buckling load  $f_i = \lambda_i f_0$ , where  $f_0$  represents a static reference loading vector of nodal forces/torques.

Edit node 3 to apply a vertical force with a magnitude of 1 N in the negative  $y$  direction.

Determine the equilibrium configuration and the critical loading parameter  $\lambda_1$ :

```
>> spacar(8, 'pf2db')
>> eig(-k0, g0)           = 78.7500
>> spavisual('pf2db')
```

## 3-DOF model

- Release elongations  $e_1$  of both leaf springs as well.

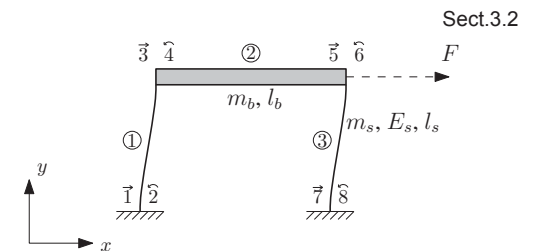

$NDOF = NX - NXO - NEO = 3$  as

$NX = 12$  is the number of nodal coordinates ( $4 \times 2 + 4 \times 1$ ),

$NXO = 6$  the number of absolute constraints (Fixed  $2 \times 2 + 2 \times 1$ ),

$NEO = 3$  the number of relative constraints, so only the solid bar

So  $NDOF = 3$ : E.g.  $x$  and  $y$  coordinates of node 3 plus rotation of node 4.

Next to the first natural frequency (10.6 Hz), now also higher natural frequencies are found (2129 Hz and 3585 Hz), justifying the previous 1-DOF approximation.

### Three-dimensional model

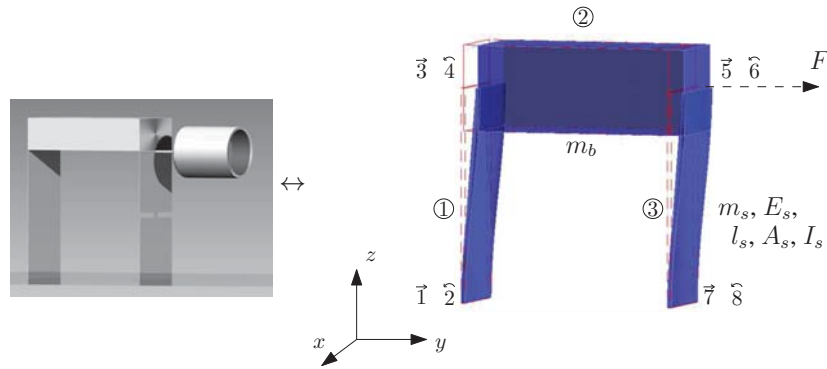

- Modelled with *spatial* elements.
- Translational and rotational *spatial* nodal points.

### Spatial beam element (BEAM)

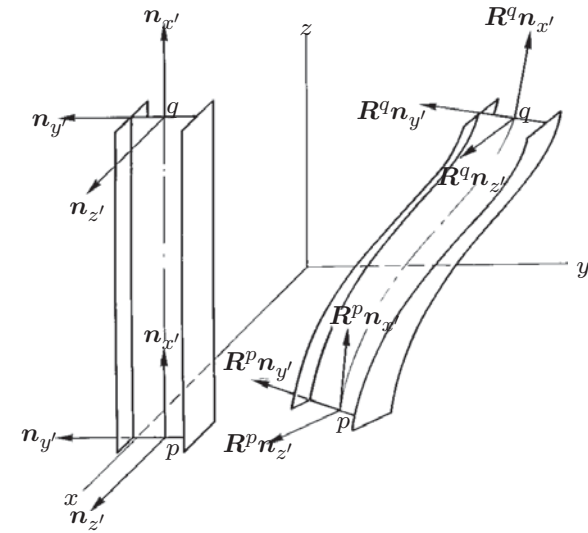

### Spatial beam element (BEAM) (2)

- Six translational coordinates are from two position vectors  $x^p$  and  $x^q$  describing the position of the beam in the fixed inertial coordinate system.
- Six independent rotational coordinates as the orientation of each rotational node in three dimensions is given by three independent rotation coordinates collected in the vectors  $\lambda^p$  and  $\lambda^q$  respectively.  
→ orientation of the triads  $(n_{x'}, n_{y'}, n_{z'})$  at the nodes  $p$  and  $q$ .

- Spatial beam: 12 (independent) nodal coordinates.

As a rigid body: 6 degrees of freedom.

So  $12 - 6 = 6$  independent deformation parameters:

elongation:  $e_1^{(k)} = l^{(k)} - l_0^{(k)}$ ,

torsion:  $e_2^{(k)} = \frac{1}{2} l_0^{(k)} [(R^p n_{z'}, R^q n_{y'}) - (R^p n_{y'}, R^q n_{z'})]$ ,

bending:  $e_3^{(k)} = -(R^p n_{z'}, l^{(k)})$ ,  $e_4^{(k)} = (R^q n_{z'}, l^{(k)})$ ,

$e_5^{(k)} = (R^p n_{y'}, l^{(k)})$ ,  $e_6^{(k)} = -(R^q n_{y'}, l^{(k)})$ .

### 1-DOF model

$$\begin{aligned} \text{NDOF} &= \text{NX} - \text{NXO} - \text{NEO} \\ &= 24 - 12 - 11 \\ &= 1, \end{aligned}$$

Note: Internally in SPACAR rotational nodal points are described by so-called Euler parameters (4 in each node) ⇒ NX and NEO are counted differently.

NX = 24 is the number of nodal coordinates ( $4 \times 3 + 4 \times 3$ ),

NXO = 12 the number of absolute constraints (Fixed  $2 \times 3 + 2 \times 3$ ),

NEO = 11 the number of relative constraints, so  $3 \times 6 - 11 = 7$  deformation parameters have to be released,

NDOF = 1: Horizontal position of node 3.

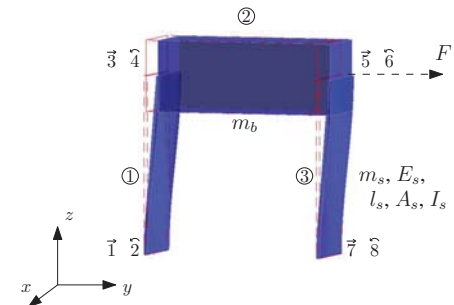

## 1-DOF model (2)

- Create a 3D model with 3 *spatial* beams. The beams' principle  $y'$  axes must be specified.
- Set the coordinates of the supports to **Fixed**.
- Release the bending modes  $e_5$  and  $e_6$  of both leaf springs.
- In addition the torsion and remaining bending modes of element 3 are released in accordance with the local cut in the leaf spring.

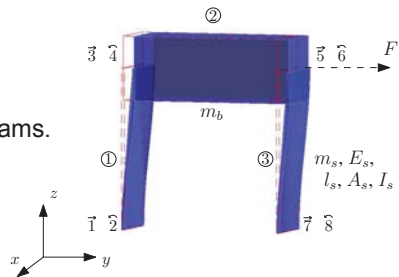

## 1-DOF model (3)

- Define lumped and/or distributed masses and inertia properties.  
→ Calculate Inertia button.
- Define the axial rigidity  $EA$  (related to longitudinal stiffness  $EA/l$ ), torsional rigidity  $GI_t$  (related to the (equivalent) torsional stiffness  $GI_t/l^3$ ), and flexural rigidities  $EI_{y'}$  and  $EI_{z'}/l^3$  (related to bending stiffnesses  $EI_{y'}/l^3$  and  $EI_{z'}/l^3$ ).  
→ Calculate button.
- Damping properties.

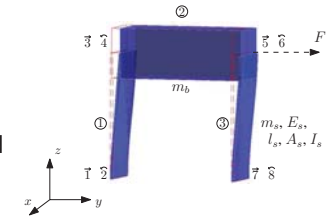

Analysis in MATLAB as before ...

## 19-DOF model

Modelling the leaf spring2 more accurately with five beams and releasing 25 deformations:

$$\begin{aligned} \text{NDOF} &= \text{NX} - \text{NXO} - \text{NEO} \\ &= 2 * 7 * 3 - 12 - (6 + 5) \\ &= 19, \end{aligned}$$

$\text{NX} = 42$  is the number of nodal coordinates ( $7 \times 3 + 7 \times 3$ ),  
 $\text{NXO} = 12$  the number of absolute constraints ( $\text{FIX } 2 \times 3 + 2 \times 3$ ),  
 $\text{NEO} = 11$  the number of relative constraints (only solid bar and elongations),  
 $\text{NDOF} = 19$ : Translation of solid bar plus additional deformations.

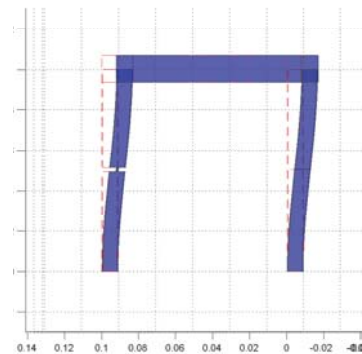

Sect.4.2

## Von Mises stresses

SPAVISUAL can also visualise the stress distribution in flexible spatial beams, e.g. in the 19-DOF model with a horizontal force of 1 N:

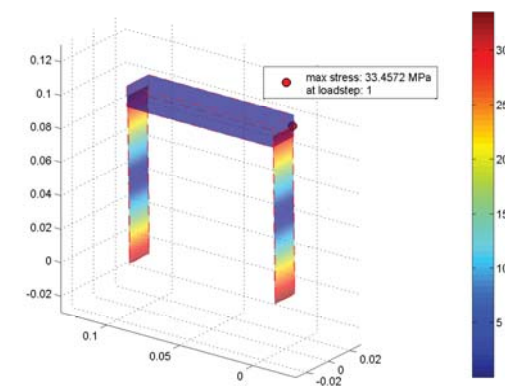



## Modules in SPACAR/MATLAB

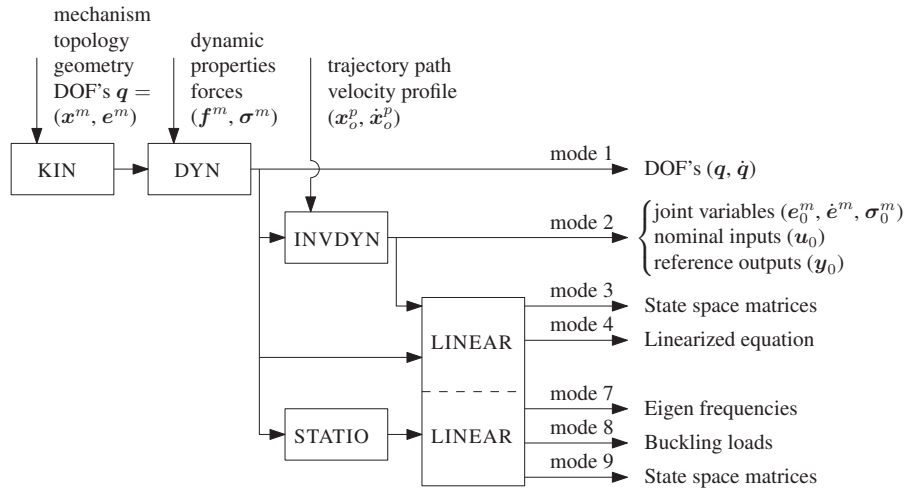

## SPACAR in MATLAB and SIMULINK

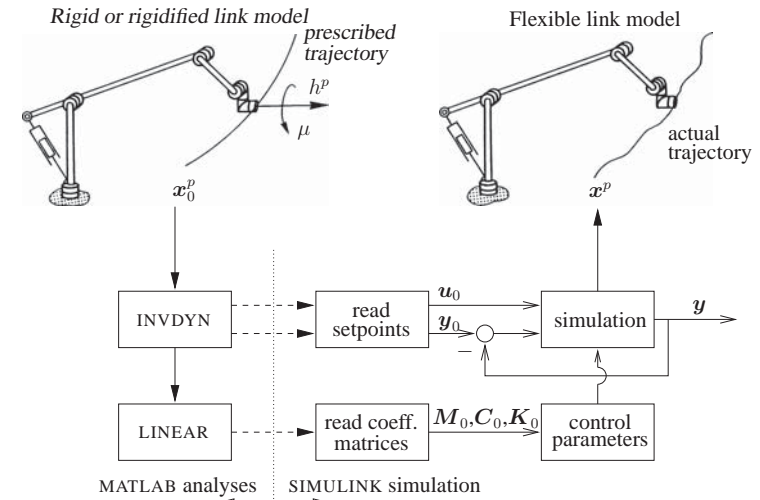

## Rigid spatial manipulator mechanism

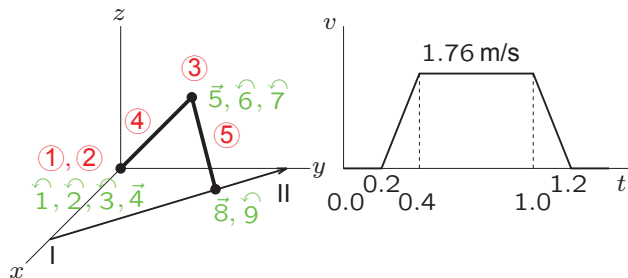

Spatial manipulator with two (rigid) links (BEAM) ④, ⑤ and three rotational joints (HINGE) ①, ②, ③.

Prescribed trajectory: Tip motion along straight line with desired velocity profile.

## Procedure (preliminary MATLAB analysis):

`invdyn computation spacar(2, 'robotinv')`:

- Define the correct degrees of freedom and deformation modes for the inverse dynamics in the kinematics part.
- Define the trajectory.
- Define the nominal inputs and reference outputs to be used in a future simulation.

`linear computation spacar(3, 'robotinvlin')` using the data from the previous `invdyn` run:

- Define the degrees of freedom for the forward dynamics.
- Define the inputs and outputs to be used in a future simulation.
- Compute e.g. the required (*nominal*) input torques and system matrices (to be discussed later).

## Simulation (SIMULINK) – open-loop:

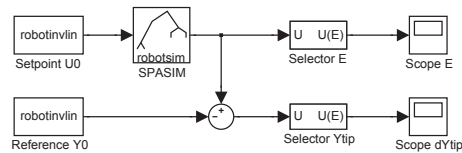

- `spasim` provides a SIMULINK interface similar to a `mode=1` (forward dynamic) SPACAR analysis.
- The system's inputs and outputs have to be specified explicitly in the input file: `INPUTS`, `OUTE`, `OUTEP`, `OUTX`.
- Read nominal inputs  $u_0$  and connect to mechanism inputs.
- Compare mechanism outputs to reference outputs  $y_0$ .
- Note that this open-loop manipulator is unstable.

## Simulation (SIMULINK) – closed-loop:

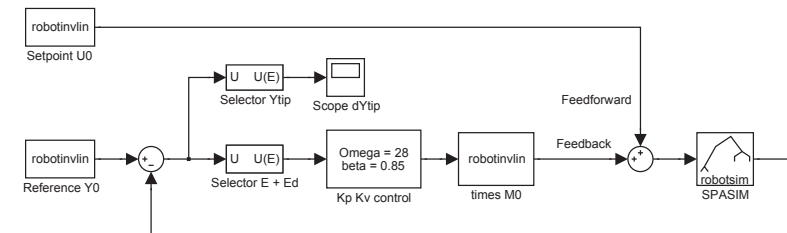

- Nominal inputs  $u_0$  can be used as a feed-forward signal.
- Compare mechanism outputs  $y$  to reference outputs  $y_0$  and use the difference for feed-back control.
- The `times M0` block multiplies the manipulator with its reduced mass matrix to change it into a MIMO  $1/s^2$  system.
- The closed-loop system with PD-like control is stable.

## Flexible spatial manipulator mechanism

- Redo `invdyn` and `linear` analyzes with modified input files including deformations representing the flexibility of the beams.
- Redo the SIMULINK simulation with this mechanism. A non-linear simulation with SPASIM can be very time consuming!
- Alternatively, a linearized set of equations can be solved in SIMULINK using the `ltv` block.
- Further reduction in CPU time is possible by applying modal techniques.