

**Msc thesis in Civil Engineering and Management**

# **The dynamics of environmental systems**

**investigating sustainability behavior**



**Christian Broekroelofs**

**August 2015**

“Everything we think we know about the world is a model. Our models do have a strong congruence with the world. Our models fall far short of representing the real world fully.” – Donella H. Meadows

# **The dynamics of environmental systems**

**investigating sustainability behavior**

**Msc thesis in Civil Engineering and Management**

Author: Ing. G.C. Broekroelofs

Date: August 12, 2015

Version: Final

Supervisors: Prof. dr. ir. A.Y. Hoekstra  
*University of Twente, Department of Water Engineering & Management*

Dr. M.S. Krol  
*University of Twente, Department of Water Engineering & Management*

Front picture: the source of the front picture is: <http://www.scalefreeintl.com/Sustainability.aspx>

**UNIVERSITY OF TWENTE.**

## Abstract

In this master thesis an investigation is done about the environmental sustainability behavior of three renewable environmental systems by using a system dynamic modeling approach. Environmental sustainability often include two simple sustainability rules. These rules imply that harvest rates should be within the systems regenerative capacity and that waste emissions should be kept within the systems assimilative capacity. Due to natural outflows and inflows in environmental systems, these rules are actually defined too wide. However, these rules also indicate that environmental sustainability is directly dependable on the systems regeneration/assimilative capacity.

The three environmental systems that are investigated are groundwater in an aquifer, biomass in a forest and pollution in a lake. These environmental systems are modeled in software program Netlogo according to the system dynamic modeling approach. All the environmental systems have four parameters that represent the circumstances of the environmental system and two environmental sustainability criteria. The environmental sustainability criteria may be in the form of relative criterion, absolute reduction criterion or fixed absolute criterion. On the basis of the environmental sustainability criteria the maximum sustainable yield or load (MSY/MSL) can be determined. Firstly, a quantitative investigation is done about how the MSY or MSL is changing when the circumstances of the environmental systems changes. This will give insight in the sensitivity of the MSY or MSL on parameter variability. The environmental sustainability criteria that gives the lowest MSY or MSL is the decisive criterion. How the decisiveness of both environmental sustainability criteria react on the parameter variability is also investigated in the quantitative part. In the second part the three environmental systems are compared on their qualitative behavior and characteristics. Inflow behavior minus outflow behavior will give the systems behavior line. The shape of this line determines how a yield or load disturbance will affect the environmental systems. From this behavior line also the stability of the environmental system can be determined. Finally, how the MSY and MSL are changing on variability in regeneration/assimilative capacity for different types of environmental sustainability criteria is investigated.

The environmental sustainability is not always dependable on the systems regeneration/assimilative capacity. In this study two exceptions were found whereby the MSY or MSL will stay constant when varying the regeneration or assimilative capacity of the system. The exceptions depend on the stability and linearity of the system (behavior line), type and place of criteria and the way variability in regeneration/assimilative capacity is incorporated.

## **Preface**

This thesis finishes the Master civil engineering and management at the University of Twente in Enschede. The study direction is Water engineering and management. The research was done at the University of Twente internally.

Thinking in systems was the most hard shift in thinking during my graduation project. The book *Thinking in systems* of D.H. Meadows really helped me in this research. The fact that there are many systems around you wherever you are and that even that cup of coffee next to you can be described as a system is fascinating. Thinking in systems may turn very complex problems in a more understandable and clear way.

I would like to thank my supervisors Arjen Hoekstra and Maarten Krol for their guidance during my graduation project. Also their feedback, advice and suggestions were much appreciated during the progress meetings.

## Table of Contents

List of figures and tables.....	vi
1. Introduction.....	1
1.1 Background information.....	1
1.2 Goal of research .....	2
1.3 Research questions.....	3
1.4 Preview .....	3
2. Case approach .....	4
2.1 Procedure of investigation .....	4
2.2 General assumptions.....	6
3. Environmental systems .....	7
3.1 Groundwater aquifer model .....	7
3.1.1 Model set up.....	7
3.1.2 Initial conditions and assumptions.....	8
3.1.3 Results .....	9
3.1.4 Environmental Sustainability criteria .....	11
3.1.5 Maximum sustainable yield.....	11
3.1.6 Investigation of parameter variability on MSY.....	12
3.1.7 Sensitivity analysis of MSY.....	16
3.1.8 Tipping line of the environmental sustainability criteria .....	17
3.1.9 Feedback to reality .....	21
3.2 Biomass in a forest model .....	22
3.2.1 Model set up.....	22
3.2.2 Initial conditions and assumptions.....	23
3.2.3 Results .....	24
3.2.4 Environmental sustainability criteria.....	26
3.2.5 Maximum sustainable yield.....	26
3.2.6 Investigation of parameter variability on MSY.....	27
3.2.7 Sensitivity Analysis of MSY .....	30
3.2.8 Tipping line of the environmental sustainability criteria .....	32
3.2.9 Feedback to reality .....	36
3.3 Pollution in Lake model .....	37

---

3.3.1	Model set up.....	37
3.3.2	Initial conditions and assumptions.....	39
3.3.3	Results .....	39
3.3.4	Environmental sustainability criteria.....	40
3.3.5	Maximum sustainable load .....	41
3.3.6	Investigation of parameter variability on MSL.....	42
3.3.7	Sensitivity analysis of MSL.....	46
3.3.8	Tipping line of the environmental sustainability criteria .....	47
3.3.9	Feedback to reality .....	50
4.	Comparison of the three models .....	52
4.1	Inflow characteristics .....	53
4.2	Outflow characteristics.....	54
4.3	Characteristics of the systems.....	55
4.4	Sustainability characteristics .....	56
4.5	Major assumptions of the models.....	62
5.	Discussion .....	64
6.	Conclusions.....	66
7.	References.....	68
	Appendix I: Netlogo codes .....	72

## List of figures and tables

FIGURE 1: HYSTERESIS LOOP .....	1
FIGURE 2: SYSTEM DIAGRAM.....	4
FIGURE 3: SYSTEM DIAGRAM OF A GROUNDWATER MODEL.....	7
FIGURE 4: CONCRETIZATION OF THE GROUNDWATER AQUIFER .....	8
FIGURE 5: GROUNDWATER LEVELS OVER TIME WITH DIFFERENT ABSTRACTION RATES .....	9
FIGURE 6: RELATION BETWEEN GROUNDWATER ABSTRACTION AND EQUILIBRIUM GROUNDWATER LEVEL ....	10
FIGURE 7: RELATION BETWEEN GROUNDWATER ABSTRACTION RATES AND EQUILIBRIUM GROUNDWATER DISCHARGE .....	10
FIGURE 8: MSY RELATED TO VARIABILITY OF RECHARGE .....	13
FIGURE 9: MSY RELATED TO VARIABILITY OF BETA.....	13
FIGURE 10: MSY RELATED TO VARIABILITY OF THE SURFACE AREA .....	14
FIGURE 11: MSY RELATED TO VARIABILITY OF THE RESIDENCE TIME.....	14
FIGURE 12: MSY RELATED TO VARIABILITY OF C1 .....	15
FIGURE 13: MSY RELATED TO VARIABILITY OF C2 .....	15
FIGURE 14: SENSITIVITY OF MSY ON PARAMETER VARIABILITY FOR C1 .....	16
FIGURE 15: SENSITIVITY OF MSY ON PARAMETER VARIABILITY FOR C2.....	17
FIGURE 16: RELATION BETWEEN C1 AND C2 FOR GROUNDWATER .....	18
FIGURE 17: RELATION BETWEEN C1 AND C2 FOR VARYING RECHARGE VALUES .....	18
FIGURE 18: RELATION BETWEEN C1 AND C2 FOR VARYING BETA VALUES .....	19
FIGURE 19: RELATION BETWEEN C1 AND C2 FOR VARYING VALUES OF THE SURFACE AREA.....	19
FIGURE 20: RELATION BETWEEN C1 AND C2 FOR VARYING VALUES OF THE RESIDENCE TIME .....	20
FIGURE 21: CHATEAUGUAY RIVER AQUIFERS .....	21
FIGURE 22: SYSTEMS DIAGRAM OF BIOMASS IN A FOREST.....	22
FIGURE 23: RELATION BETWEEN THE VOLUME OF BIOMASS AND DIFFERENT ABSTRACTION INTENSITIES.....	24
FIGURE 24: RELATION BETWEEN THE EQUILIBRIUM VOLUME OF BIOMASS AND THE ABSTRACTION INTENSITY	25
FIGURE 25: RELATION BETWEEN THE EQUILIBRIUM VOLUME OF DEAD BIOMASS AND THE ABSTRACTION INTENSITY .....	25
FIGURE 26: MSY RELATED TO VARIABILITY OF THE GROW RATE.....	27
FIGURE 27: MSY RELATED TO VARIABILITY IN MORTALITY RATE.....	28
FIGURE 28: MSY RELATED TO VARIABILITY OF THE CARRYING CAPACITY .....	28
FIGURE 29: MSY RELATED TO VARIABILITY OF THE DECOMPOSITION RATE .....	29
FIGURE 30: MSY RELATED TO VARIABILITY OF C1 .....	29
FIGURE 31: MSY RELATED TO VARIABILITY IN C2.....	30
FIGURE 32: SENSITIVITY OF MSY ON PARAMETER VARIABILITY FOR C1.....	31
FIGURE 33: SENSITIVITY OF MSY ON PARAMETER VARIABILITY FOR C2.....	31
FIGURE 34: RELATION BETWEEN C1 AND C2 FOR BIOMASS IN A FOREST .....	32
FIGURE 35: RELATION BETWEEN C1 AND C2 FOR VARYING GROW RATES .....	33
FIGURE 36: RELATION BETWEEN C1 AND C2 FOR VARYING MORTALITY RATES .....	33
FIGURE 37: RELATION BETWEEN C1 AND C2 FOR VARYING CARRYING CAPACITIES .....	34
FIGURE 38: RELATION BETWEEN C1 AND C2 FOR VARYING DECOMPOSITION RATES .....	34
FIGURE 39: FLOW STOCK DIAGRAM OF POLLUTION IN A LAKE .....	37
FIGURE 40: RELATION BETWEEN MASS OF POLLUTION AND LOAD RATES .....	39
FIGURE 41: RELATION BETWEEN EQUILIBRIUM AMOUNT MASS OF POLLUTION AND LOAD RATE.....	40
FIGURE 42: RELATION BETWEEN POLLUTION MASS OF NITROGEN AND PHOSPHORUS AND LOAD INTENSITY..	41
FIGURE 43: MSL RELATED TO VARIABILITY IN DISCHARGE .....	42
FIGURE 44: MSL RELATED TO VARIABILITY IN REMOVAL RATES.....	43
FIGURE 45: MSL RELATED TO VARIABILITY IN THE NITROGEN AND PHOSPHORUS RATIO OF THE LOAD .....	43

FIGURE 46: MSL RELATED TO VARIABILITY OF THE BACKGROUND CONCENTRATION OF THE INFLOW CHANNEL .....	44
FIGURE 47: MSL RELATED TO VARIABILITY OF C1 .....	44
FIGURE 48: MSL RELATED TO VARIABILITY OF C2 .....	45
FIGURE 49: SENSITIVITY OF MSL ON PARAMETER VARIABILITY FOR C1 .....	46
FIGURE 50: SENSITIVITY OF MSL ON PARAMETER VARIABILITY FOR C2 .....	46
FIGURE 51: RELATION BETWEEN C1 AND C2 FOR POLLUTION IN A LAKE.....	47
FIGURE 52: RELATION BETWEEN C1 AND C2 FOR VARYING DISCHARGE VALUES .....	47
FIGURE 53: RELATION BETWEEN C1 AND C2 FOR VARYING REMOVAL RATES.....	48
FIGURE 54: RELATION BETWEEN C1 AND C2 FOR VARYING NP RATIO VALUES .....	48
FIGURE 55: RELATION BETWEEN C1 AND C2 FOR VARYING BACKGROUND CONCENTRATIONS.....	49
FIGURE 56: OVERVIEW OF THE INVESTIGATED ENVIRONMENTAL SYSTEMS .....	52
FIGURE 57: INFLOW BEHAVIOR OF ENVIRONMENTAL SYSTEMS.....	53
FIGURE 58: OUTFLOW BEHAVIOR OF ENVIRONMENTAL SYSTEMS .....	55
FIGURE 59: BEHAVIOR OF ENVIRONMENTAL SYSTEMS .....	56
FIGURE 60: INFLUENCE OF DIFFERENT TYPES OF CRITERIA ON THE MSY FOR CHANGING GROUNDWATER REGENERATION CAPACITIES.....	58
FIGURE 61: INFLUENCE OF DIFFERENT TYPES OF CRITERIA ON THE MSY FOR CHANGING BIOMASS REGENERATION CAPACITIES.....	58
FIGURE 62: INFLUENCE OF DIFFERENT TYPES OF CRITERIA ON THE MSL FOR CHANGING POLLUTANT REMOVAL RATES.....	59
FIGURE 63: CHANGE OF GRADIENT.....	60
FIGURE 64: NON LINEAR GROUNDWATER MODEL BEHAVIOR .....	62
TABLE 1: GROUNDWATER MODEL PARAMETERS .....	12
TABLE 2: BIOMASS IN A FOREST MODEL PARAMETERS.....	27
TABLE 3: POLLUTION IN A LAKE MODEL PARAMETERS.....	42
TABLE 4: CHARACTERISTICS OF THE THREE ENVIRONMENTAL SYSTEMS .....	53
TABLE 5: PARAMETERS THAT INFLUENCE THE REGENERATION/ASSIMILATIVE CAPACITY.....	57
TABLE 6: TYPES OF ENVIRONMENTAL SUSTAINABILITY CRITERIA .....	57



## 1. Introduction

### 1.1 Background information

The world consist of many complex systems, such as the environmental systems that support and enable life on earth. Unfortunately, since the last century more and more of these environmental systems are under pressure due to for example overuse of resources and waste loads that leads to undesired loss of habitat and scarce resources (Voorn, 2012). The recently published report from the Intergovernmental Panel on Climate Change (IPCC, 2014) stated that in recent decades, changes in climate have caused impacts on natural and human systems on all continents and across the oceans. Therefore the use of resources and emissions of pollution are still not considered in a sustainable way. Sustainable use of environmental systems is highly recommended, and due to the fact that sustainability is a “trending” topic the last decade a lot of research has already been done.

Environmental systems are often complex systems. System dynamic modeling (SDM) is an approach to model complex systems like environmental systems ([www.systemdynamics.org](http://www.systemdynamics.org)). A system dynamic model is a quantitative, mathematical system model in which the temporal aspect is included, emphasizing the feedback mechanisms of the system. The development over time is calculated dynamically, with a time step aligned with the purpose of the model and the modeled processes (de Kok & Engelen, 2013). The fundamental purpose of SDM is to understand the behavior of the system rather than giving a precise representation of reality (Forrester, 2007). A system diagram consist of entities that can be a flow or a stock. The stocks are the memory of a dynamic system and the flows are the processes that affect them (Meadows, 2008). Furthermore, converters are the system variables and their most important role is to dictate the rates at which the processes operate and therefore the rates at which stock contents change (Deaton & Winebrake, 2000). The feedback mechanisms in a system diagram are shown as a curved arrow (see figure 2). A feedback mechanism may be in the form of a balancing feedback or a reinforcing feedback. A balancing feedback is equilibrating or goal seeking while a reinforcing feedback is self enhancing, that might lead to exponential growth or runaway collapses. With the SDM approach, environmental systems can be modeled while the complexity is kept to a minimum.

The tipping point from where an environmental system may turn from clear state to a turbid state or vice versa has been investigated by Voorn (2012). He argues that commonly these tipping points are not linear related. When an environmental systems is near its tipping point the system may seemingly undergo large changes as a result of a small disturbance or change in input, settling into a new state (Voorn, 2012). For example a forest that changes to grassland due to logging or less rainfall. Figure 1 gives a clear explanation of what a non linear tipping point may look like for phosphorus concentration in surface water. The graph in

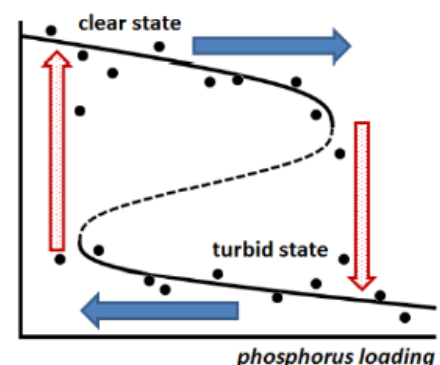

Figure 1: Hysteresis loop

Figure 1 is called the hysteresis effect whereby a much greater reduction in the concentration of phosphorus is needed to restore the lake to a clear state once it is in turbid state. One should consider defining the environmental sustainability criteria precisely before the tipping point of the environmental system. Though in this study the environmental sustainability criteria is based on

literature and therefore the investigation only occurs in the area between full clear state and the tipping point. The presence of a tipping point also depends on the characteristics and behavior of the environmental system. Later in this study the tipping points in environmental systems are treated.

Sustainability of environmental systems is a very wide understanding. Sustainability is often divided in three components namely: social, economic and environmental sustainability (Goodland, 1995). This study focuses on the environmental sustainability; economic and social sustainability are beyond the scope of this research. Goodland (1995) investigated the environmental sustainability (ES) and came to the following two sustainability rules for renewable environmental systems with respect to harvest rates and waste emissions.

1. Waste emissions should be kept within the assimilative capacity of the system without unacceptable degradation of its future waste absorptive capacity or other important services.
2. Harvest rates of renewable resource inputs should be within regenerative capacities of the natural system that generates them.

These rules are supported by Costanza & Daly (1992). The sustainability rules indicate that the range of sustainable harvesting or emissions is between zero and regeneration/assimilation capacity, which may be a wide range.

Though much research has been done in modeling environmental systems and about the sustainability of environmental systems, there is still a lack of information about how environmental systems behave under disturbances and different circumstances. The maximum sustainable yield (MSY) and maximum sustainable load (MSL) are terms that are frequently used in this research. Both terms are the maximum value of disturbance of the environmental system without violating the environmental sustainability criteria. Much research has been done about MSY and MSL. For instance, Lande, Sæther, & Engen (1997) argue that optimal strategies for harvesting renewable resources always involves a critical threshold value above which all excess can be harvested. This would mean that the sustainability criterion would be in the form of a fixed value and the MSY is defined as everything that exceeds this fixed level. While others are estimating the MSY based on the mortality of specific species, due to the lack of data (Garcia, Sparre, & Csirke, 1989). Furthermore, Kar & Ghosh (2013) defined a MSY based for a single fish stock. They found out that if this MSY is applied to a prey predator fish model, then this would result in eventually the extinction of the predator. Sustainability implies that all tropic levels in a food chain must persist and therefore fishing at the MSY of a single fish stock in a prey predator model is not sustainable. The concept of the maximum sustainable yield/load is very complex and there is a lot of ambiguity about how to use this concept.

## **1.2 Goal of research**

The goal of this research is to explore the characteristics of environmental systems that determine the behavior and explain why an environmental system is behaving like it does. Also providing insight in how the MSY or MSL will change when the parameters of the environmental system change. Therefore the environmental sustainability is a key aspect in this study.

The environmental systems that will be investigated in this study is groundwater in an unconfined renewable aquifer, biomass in a forest and pollution in a lake. The decision to chose these

environmental systems is based on previously found characteristics. For a good comparison the environmental systems should not be too similar. The biomass in a forest system is different from the other two systems, because it's a population based model (self reproducing), that has a non linear component in it. The pollution in a lake system is different from the other two systems, because it is a waste system instead of a resource system. Furthermore, all the systems are renewable systems, because the sustainability of a non renewable system lies outside the system itself. Sustainability of non renewable resources is defined as follows: "the depletion rate of non renewable resources should be set below the rate at which renewable substitutes are developed by human invention and investment" (Goodland, 1995). This means that the sustainability of the environmental system is measured outside the system itself.

### **1.3 Research questions**

The purpose of the study is concretized in one main question and 3 sub questions.

What fundamental characteristics of an environmental system define the systems behavior with respect to the environmental sustainability of the system?

Sub questions:

How do the qualitative characteristics influence the systems behavior?

What are the different types of environmental sustainability criteria that can be posed per environmental system?

How do changes of parameters affect the MSY or MSL?

### **1.4 Preview**

Hereafter the case approach is described in chapter 2, followed by a description of the environmental systems and their behavior with respect to the environmental sustainability criteria, circumstance changes and the maximum sustainable yield/load in chapter 3. Chapter 4 includes a comparison of the environmental systems and a description of behavior and characteristics. Chapter 5 discusses the results that are presented in chapter 3 and 4. The report finishes with chapter 6 which describes the conclusions.

## 2. Case approach

The next procedure has been followed in this study, whereas step one until six is repeated for every environmental system separately. Step seven is a general step.

### 2.1 Procedure of investigation

#### Step 1: Select entities of environmental systems

Firstly it is analyzed on what entity of the environmental system sustainability can be determined. Sustainability of an environmental system is often not indicated by only one element but by more (McBride et al., 2011). Therefore it was chosen to always implement two environmental sustainability criteria in each model. Entities can either be a flow or a stock. The sustainability criteria may be located on a stock or flow. Besides, also the disturbance entity is determined which may be an emission or a yield. The load disturbance type is represented as an inflow, while the yield disturbance type is represented as an outflow. In Figure 2 a typical systems diagram is presented with disturbance types and places where the environmental sustainability criteria may be defined. In Figure 2 also an inflow and outflow is shown, these are commonly the natural processes that play an important role. All of the entities that are selected are provided by literature.

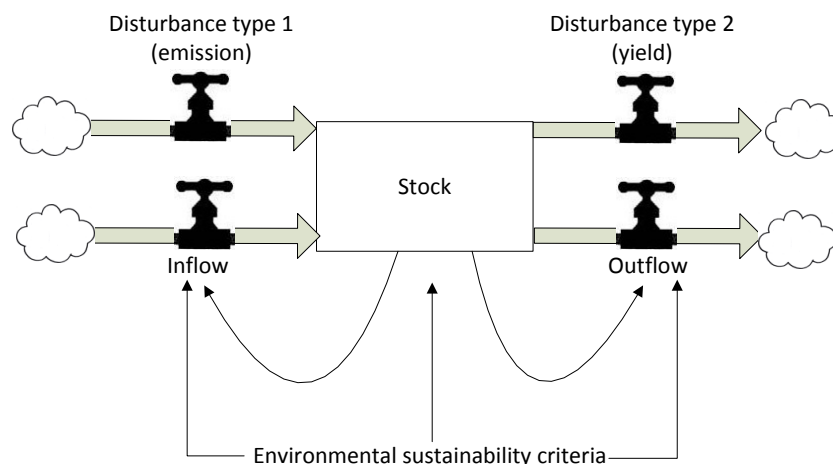

Figure 2: System diagram

#### Step 2: identify the equations and parameters of the environmental system

Now that the entities are indicated, the systems diagram of the environmental systems is complete. However, the natural processes often have a certain behavior that is described by an equation. These equations contain parameters that describes the rate at which the natural processes operate. The value of some parameters are assumed on the forehand, however the parameters may also be indicated as variable. The variable parameters present the circumstances of the environmental system, whereby the range at which they operate needs to be determined. The identification of the equations, their according parameter and the range of the parameters are done through literature search.

**Step 3: Implement the system diagram into Netlogo**

When the entities and equations are determined the environmental system is ready for implementation into Netlogo. Netlogo is a software to model and simulate natural and/or social phenomena (Wilensky, 1999). The codes that are used to model each environmental system are shown in appendix I.

**Step 4: Define minimum or maximum values for the sustainability entities**

The next step in the investigation procedure is to define maximum or minimum values for the entities that represent the sustainability of the environmental system. These environmental sustainability criteria may be set as thresholds, maximum increases/decreases or percentages reduction/enlargement. Besides, these environmental sustainability criteria are also considered as parameters of the environmental systems. The environmental sustainability criteria are based on values that are used in case studies of literature.

**Step 5: Determine the MSY and MSL and investigate influence on parameter variability**

By using the Netlogo model, the maximum sustainable yield or maximum sustainable load can be determined. The maximum sustainable yield (MSY) is the maximum harvest from a resource that can be gathered without violating the environmental sustainability criteria. The maximum sustainable load (MSL) is the maximum load that can be deposited in the environmental system without violating the environmental sustainability criteria.

This MSY or MSL depends heavily on the circumstances of the environmental system. One will argue that the maximum sustainable yield of a renewable groundwater aquifer is larger for areas where more precipitation is falling. The circumstances of the environmental system are represented by the parameters of each model. By changing the parameters individually the maximum sustainable yield or load may also change, which will give insight in how the system works and which parameters are important in the environmental system with respect to the maximum sustainable yield or load.

To know how sensitive the maximum sustainable yield is on parameter changes, a scaling procedure is applied. This scaling procedure will divide the value of the parameter by its default value, wherefore every parameter is getting a dimensionless unit. In this way, insight is given in the sensitivity of the maximum sustainable yield on parameter variability.

The investigations that are done in this step are all based on the output of the models.

**Step 6: Investigate the decisiveness of the environmental sustainability criteria**

Due to the fact that each environmental system has two sustainability criteria the maximum sustainable yield or load is determined by only one of the two criteria, namely the criteria that is violated first when increasing the yield or load. This criteria is the decisive criterion for determining the maximum sustainable yield or load. Nonetheless, the criteria may be chosen such that both environmental sustainability criteria are violated at the same time, wherefore both criteria are decisive. A tipping line can be drawn for combinations of criteria whereby both criteria are decisive. This line is also the separation from where the decisiveness changes from criterion 1 to criterion 2 or

vice versa. Parameter variability (circumstance changes) is also investigated on the decisiveness of environmental sustainability criteria per environmental system.

#### **Step 7: Compare system characteristics**

Finally, a comparison will be made between the three models on their behavior. Seeking for distinguished characteristics of the environmental systems that can explain why a system behaves like it does. Also an investigation will be done what would happen to the system when one of these distinguished characteristics is changed. Furthermore, the influences of different types of criteria will be investigated and what would happen to the systems behavior if major assumptions are changed.

### **2.2 General assumptions**

Most of the assumptions that were done are environmental system specific and will be treated in chapter 3. However, some assumptions are applicable on all the environmental systems which are listed below:

- All the models do not contain spatial variations;
- Each model has 2 environmental sustainability criteria and 4 parameters that determine the circumstances of the model;
- All the models are renewable environmental systems;
- The models are not affected by other processes that are not shown in the system diagrams of the models;
- The yield and load disturbances to the environmental systems are assumed to be constant in time;
- The environmental sustainability is the only incorporated type of sustainability.

### 3. Environmental systems

#### 3.1 Groundwater aquifer model

The model that is schematized in this chapter is a hypothetical groundwater basin with a renewable unconfined aquifer sealed from deeper soil layers by an impermeable layer (see Figure 4). The Aquifer covers an area of 25 square kilometers with an initial groundwater depth of 1.29 meter. Furthermore, at one side of the aquifer a river is flowing that has a fixed level of 3 meters below surface. The groundwater is recharged by precipitation, but declines due to natural outflow to the nearby river and human abstraction of groundwater. The entities that are colored green in the systems diagram are the entities where sustainability will be measured.

##### 3.1.1 Model set up

The groundwater model is based on the next system diagram.

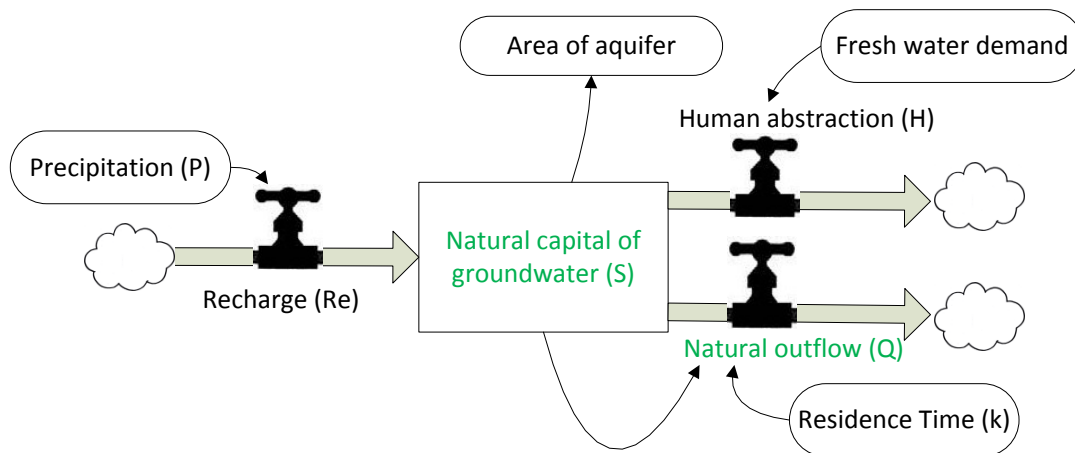

Figure 3: System diagram of a groundwater model

The equations for the different processes are shown below:

$$\frac{dS}{dt} = Re - Q - H$$

$$Re = \frac{R * A}{12000}$$

$$Q = \left(\frac{S}{r}\right)^\beta$$

$$r = \left(\frac{k}{S_{eq}}\right)^{\frac{1}{\beta}} * S_{eq}$$

$$H = \text{variable}$$

For Beta is 1 (linear system) the next equilibrium equation is valid:

$$S_{eq} = (Re * k) - (k * H)$$

Where,

$S$  = the stock groundwater in cubic meters ( $m^3$ );

$S_{eq}$  = the stock groundwater in equilibrium without human abstraction ( $m^3$ );

$R$  = the groundwater recharge in meters per day (mm/year);

$Re$  = the groundwater recharge in cubic meters per month ( $m^3$ / month);

$Q$  = Natural outflow to the river in cubic meters per month ( $m^3$ / month);

$k$  = Residence time in months (months);

$\beta$  = level of non linearity ( $\beta = 1$  linear system) (-);

$r$  = response factor ( for  $\beta = 1$  applies  $r = k$ ) (months);

$H$  = human abstraction in cubic meters per second ( $m^3$ /month);

$A$  = surface area of the aquifer in square meters ( $m^2$ ).

The recharge values are estimated with the help of the Chaturvedi equation, that can convert precipitation to recharge (Kumar & Seethapathi, 2002). Assuming that the annual rainfall is 750 millimeters (Netherlands), the annual recharge will be 135 millimeters when using the parameters of U.P. Irrigation Research institute and Roorkee.

$$R = 1.35 (P - 14)^{0.5}$$

The units are in inches and the parameters of 1.35, 14 and 0.5 are often recalibrated for different locations. The model is a hypothetical groundwater aquifer and therefore it does not matter which parameters will be used in the Chaturvedi equation.

The equation for the discharge of groundwater to surface water is used according to the Storage principle for (non) linear reservoirs, where the equation for the response factor is derived from it (Hoekstra, 2013) .

The surface area and depth of the aquifer are chosen arbitrary.

### 3.1.2 Initial conditions and assumptions

The initial conditions are made clear in the next figure. The initial groundwater level is set on the equilibrium situation that is related to  $S_{eq}$ . With the circumstances and assumptions that are mentioned in this paragraph the equilibrium groundwater level is 1.71 meter plus river level (1.29 meters below surface).

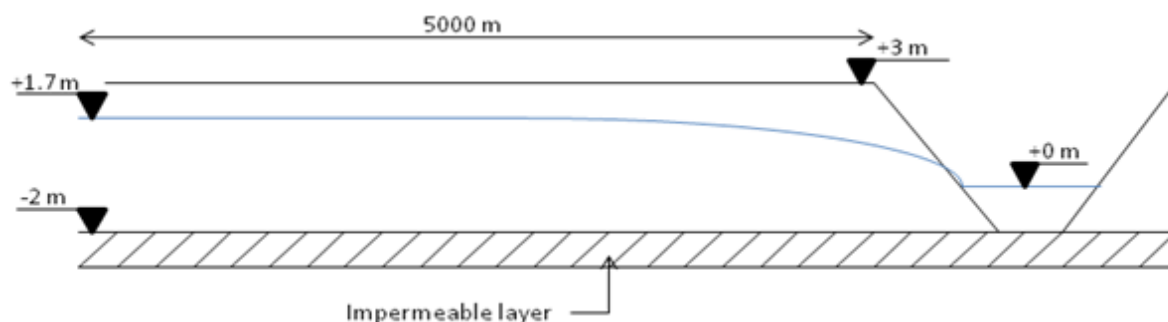

Figure 4: Concretization of the groundwater aquifer



The assumptions of the groundwater model are summed below:

- The groundwater level does not contain spatial variations;
- The surface area of the aquifer is 5000 x 5000 meters; a total of 25 km<sup>2</sup>;
- The recharge is 135 millimeter per year (e.g. 0.01125 m/month);
- Initial equilibrium groundwater level is + 1.71 meters above river level;
- The river level is a fixed reference level at +0 m;
- At -2 meters beneath the river level an impermeable layer is present;
- The run time is 200 years (2400 months);
- $\beta$  is 1 (linear reservoir);
- The model does not contain equations for flooding and seepage from river to groundwater (river level > groundwater level);
- The residence time is assumed to be 330 months.

### 3.1.3 Results

This hypothetical groundwater model is modeled in Netlogo and Figure 5, Figure 6 and Figure 7 are presenting the first results of how the system responds to a yield disturbance of the system.

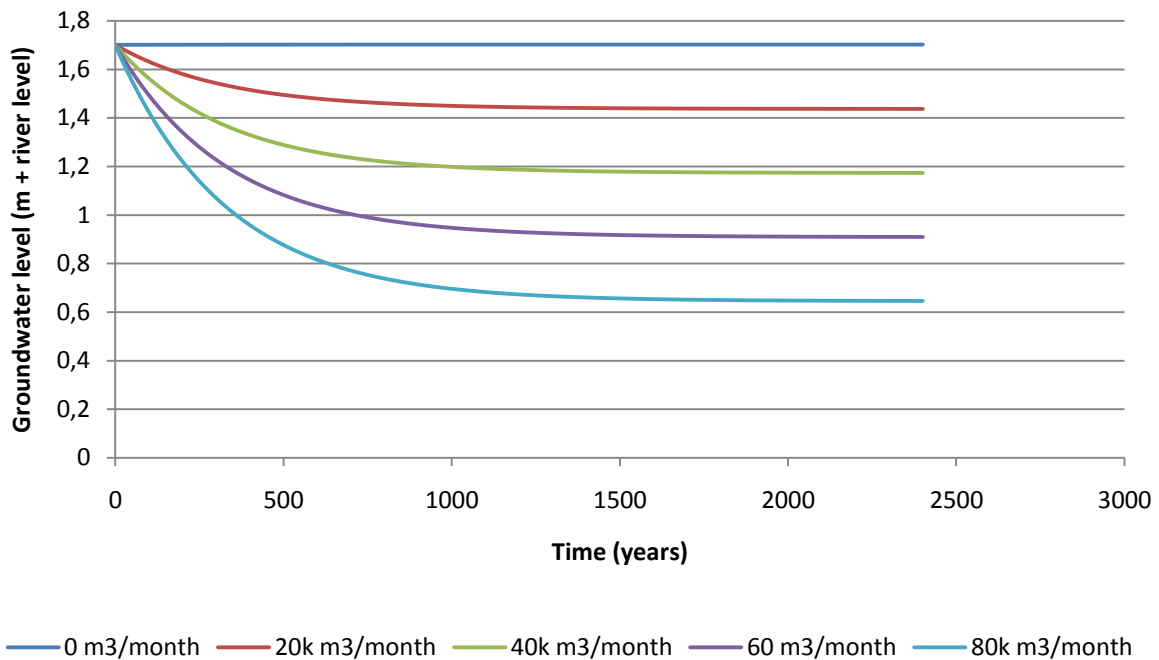

Figure 5: Groundwater levels over time with different abstraction rates

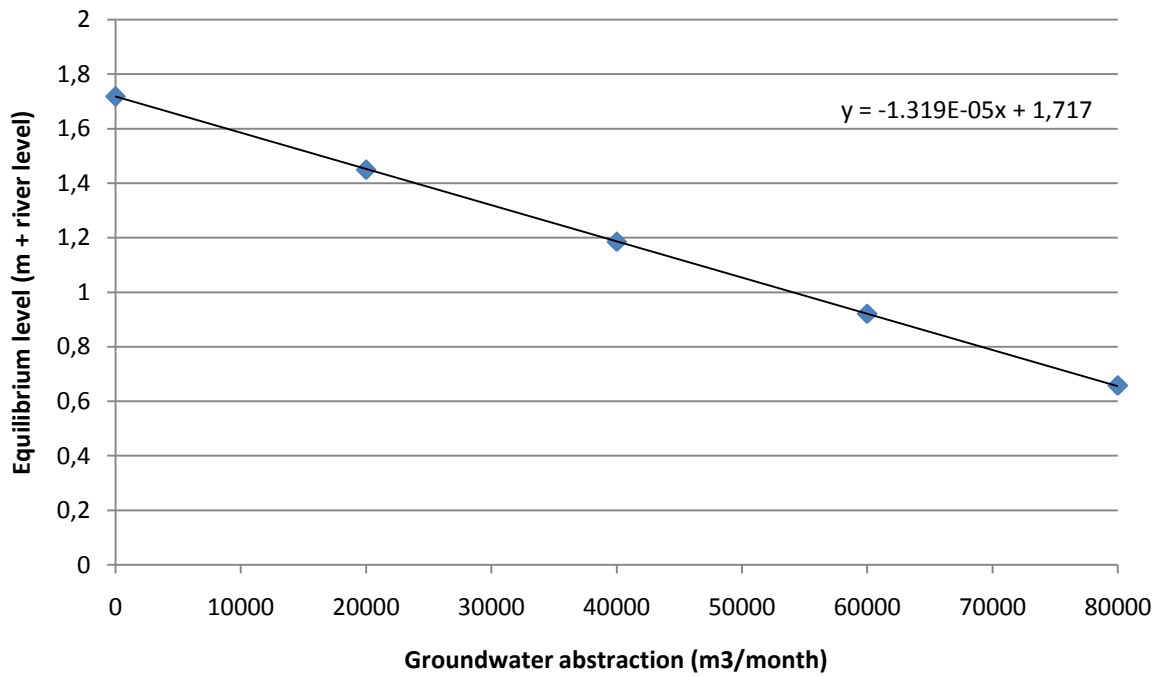

Figure 6: Relation between groundwater abstraction and equilibrium groundwater level

A linear relationship established between groundwater abstraction and the groundwater level equilibrium after 200 years. For the natural groundwater discharge a same graph can be plotted. A linear trend line is shown in both graphs with the accompanying equations.

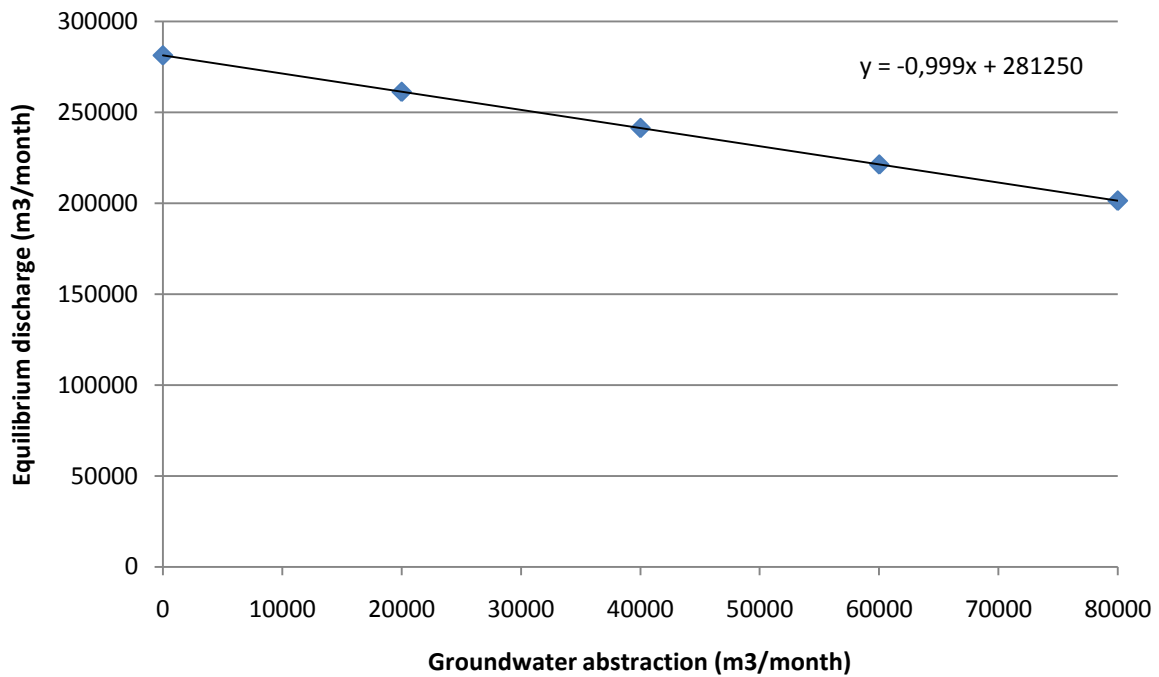

Figure 7: Relation between groundwater abstraction rates and equilibrium groundwater discharge

### 3.1.4 Environmental Sustainability criteria

Sustainability of a renewable groundwater aquifer may depend on the natural vegetation and natural outflow (Johnson et al., 2010) (Richter, Davis, Apse, & Konrad, 2011). Natural vegetation again depends on the groundwater level. In literature there are some studies that investigate the correlation between vegetation and groundwater level. Hao, Li, Huang, Zhu, & Ma, (2010) investigated this for riparian forest vegetation at the Tarim River in China. The relation between groundwater level and vegetation cover is dependent on location but also on the specie type (Cui & Shao, 2005) (Johnson et al., 2010). However, none of the investigations came to a concrete sustainability criterion. Setting an environmental sustainability criterion on groundwater level or groundwater depth is useful but also location and specie dependent. For example Johnson et al. (2010) came to the conclusion that 2 specific species already had problems to survive with < 1 m depressions in groundwater level. Therefore, implementing a maximum groundwater level drawdown from the equilibrium is a better option. This maximum groundwater level drawdown is associated with the maximum desired change in vegetation, since it uses the equilibrium situation as reference. The next environmental sustainability criterion is defined for a groundwater aquifer.

#### **Environmental sustainability criterion 1 (C1): Maximum Groundwater level drawdown: 1 meter.**

Based on the three literature studies mentioned above a maximum groundwater drawdown of 1 meter is assumed. The criterion is not a fixed value and will be considered as one of the parameters.

However, the sustainability can also be measured at the natural outflow, also called base flow of the river. In dry periods rivers are commonly only recharged by groundwater seepage. The flow in the river that is caused by groundwater is called base flow. Environmental flow is the flow that is necessary to maintain the ecosystems of the river. In Denmark they use four indicators to assess the sustainability of groundwater abstraction. One of those indicators is that the maximum reduction of base flows is 5%, 10%, 15%, 25% or 50% depending on ecological objective of the river reach (Henriksen, Troldborg, Højberg, & Refsgaard, 2008). This is a wide range to come to a concrete sustainability criterion for the environmental flow requirement. Richter, Davis, Apse, & Konrad (2011) came to a more precise criterion of the environmental flow requirement namely 80% of the base flow. Therefore, this number of 80% is assumed as environmental sustainability criterion 2.

#### **Environmental sustainability criterion 2 (C2): Minimal environmental flow requirement: 80% of base flow.**

Also this criterion is not a fixed value and will be considered as one of the parameters.

Note that C1 is an absolute reduction criterion and C2 is relative criterion. Furthermore C1 is a criterion related to the stock of the model and C2 is related to the outflow of the model.

### 3.1.5 Maximum sustainable yield

The maximum sustainable yield is the maximum yield than can be withdrawn from an aquifer without violating the environmental sustainability criteria defined in the previous paragraph. For the given circumstances the maximum sustainable yield can be calculated with the equations that are given in Figure 6 (C1) and Figure 7 (C2). According to Figure 6 and environmental sustainability criterion 1 the maximum sustainable yield is 75815 cubic meters per month. According to Figure 7 and the environmental sustainability criterion 2 the maximum sustainability yield is 56250 cubic

meters per month. In this example the maximum sustainable yield with regard to C2 is decisive, because it has the lowest MSY value. C2 will be first exceeded in this example. Hereafter the MSY according to C1 is called MSY-1, and the MSY according to C2 is called MSY-2.

### 3.1.6 Investigation of parameter variability on MSY

The previous model is based on assumptions and initial conditions. In this chapter the responding of the groundwater model on changes in circumstances will be investigated. Changes in groundwater level will be kept between the surface level and the level of the river, because the model does not contain formulas for flooding and seepage from the river to groundwater. Therefore the range of variability of the parameters are so that in equilibrium situation the groundwater level will not be higher than +3 meters and not lower than 1 meter above river level. If the groundwater level is lower than 1 meter above river level then it is not possible to determine the maximum sustainable yield according to sustainability criterion 1 which includes a maximum groundwater level drawdown of 1 meter. The next parameters are considered to present the circumstances of the groundwater aquifer:

- Recharge (R) in millimeters per year;
- $\beta$  indicates the level of non linearity of the system;
- Surface area (A) in square kilometers;
- The residence time k of the groundwater in months;
- Sustainability criteria 1 (C1) based on the maximum groundwater level drawdown in meters;
- Sustainability criteria 2 (C2) based on the environmental flow requirement in % of base flow.

Parameter	R (mm/yr)	$\beta$ (-)	A (km <sup>2</sup> )	k (months)	C1 (m)	C2 (%)
Range	110-180	0.5 - 3	10 - 80	270-390	0 -1.7	60-100
Default	135	1	25	330	1	80

Table 1: Groundwater model parameters

It will be investigated how the maximum sustainable yield changes according to C1 and C2 by only changing one parameter and keep the other parameters as their default value.

However when changing some single parameters it is unavoidable that other variables are also changing in the model. For example when the natural recharge is increasing in a groundwater system, more water will flow into the system. The equilibrium stock will therefore lie much higher than in the original situation. In the graphs this is shown as a secondary x axis above the graph or as a table below the graph. Some parameters will change the equilibrium natural capital while others will change the response factor.

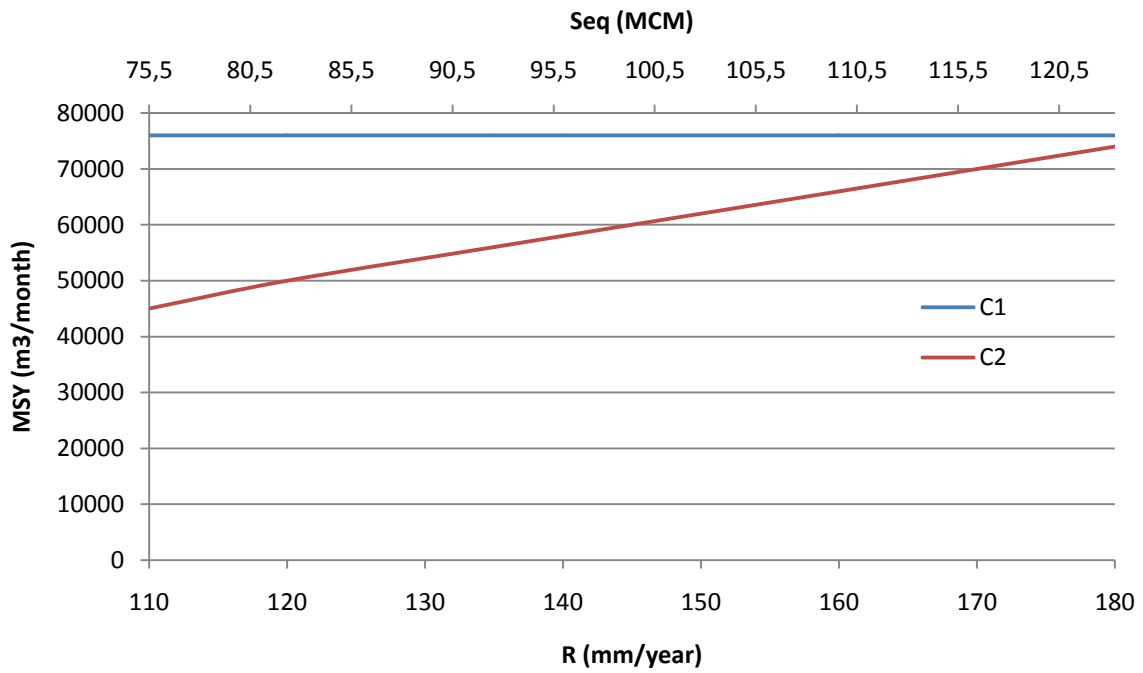

Figure 8: MSY related to variability of recharge

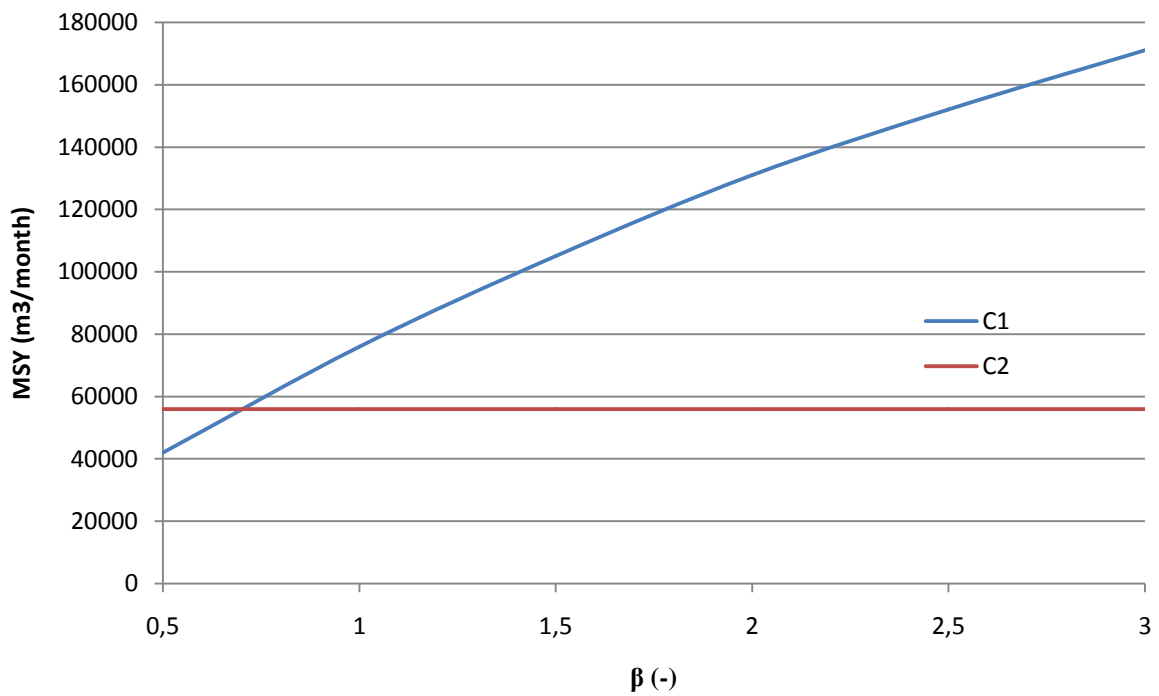

Figure 9: MSY related to variability of beta

$\beta$	0.5	1	1.5	2	2.5	3
r	0.01	330	21616	174949	613470.8	1415947

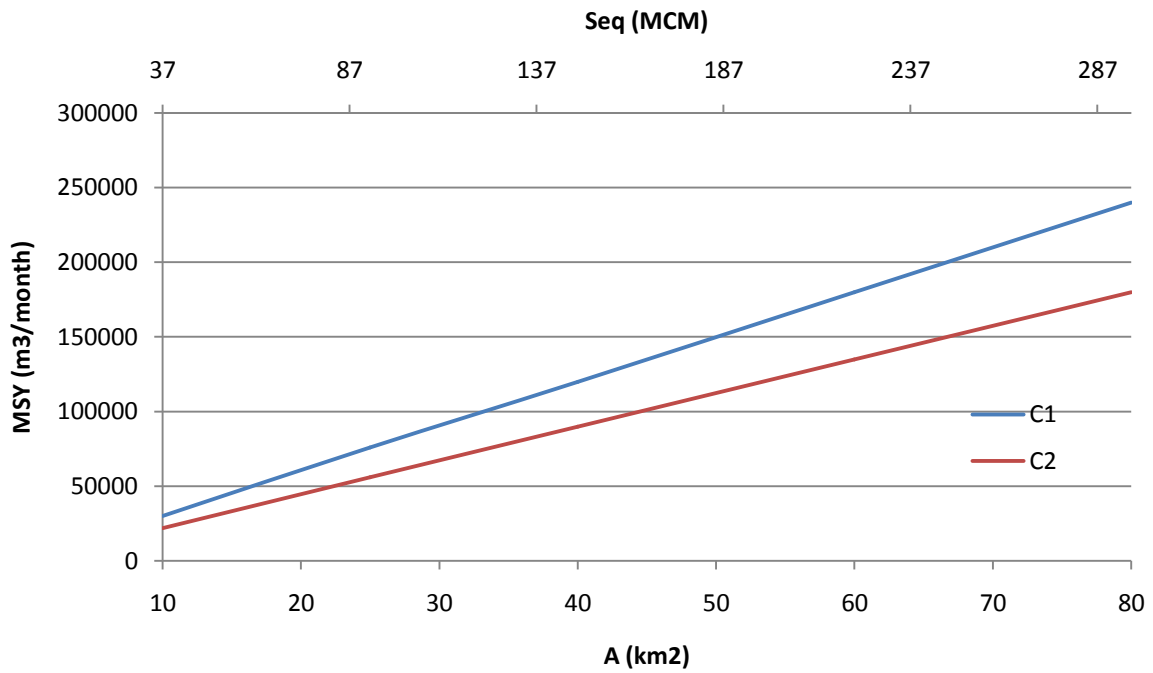

Figure 10: MSY related to variability of the surface area

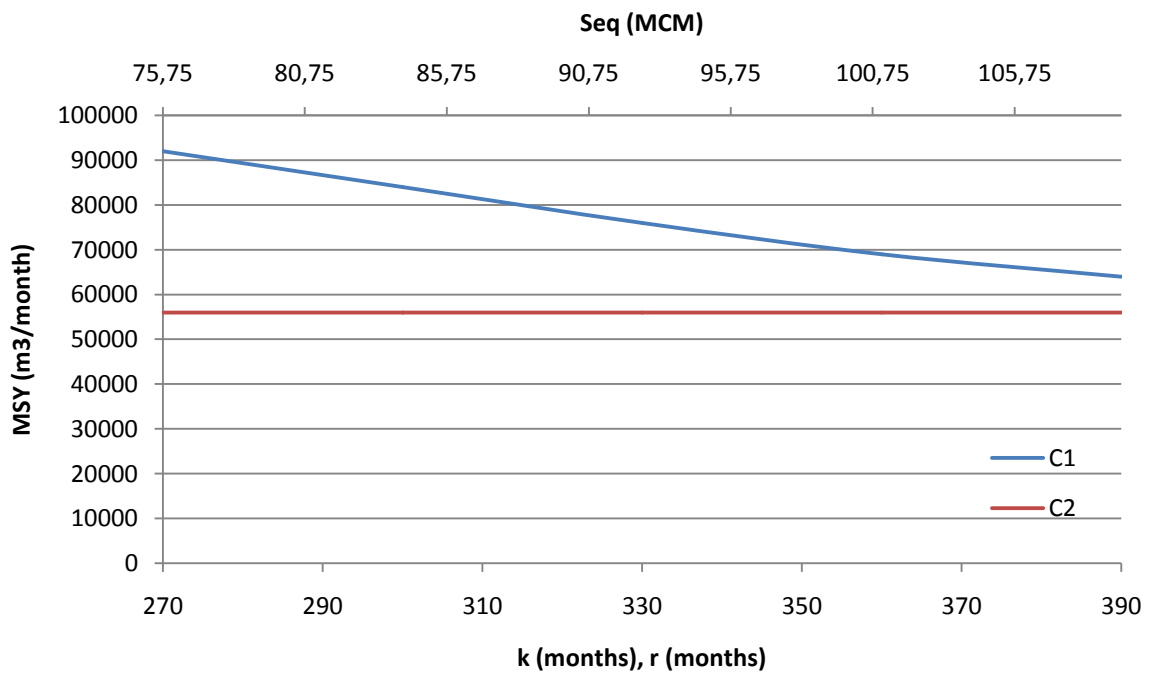

Figure 11: MSY related to variability of the residence time

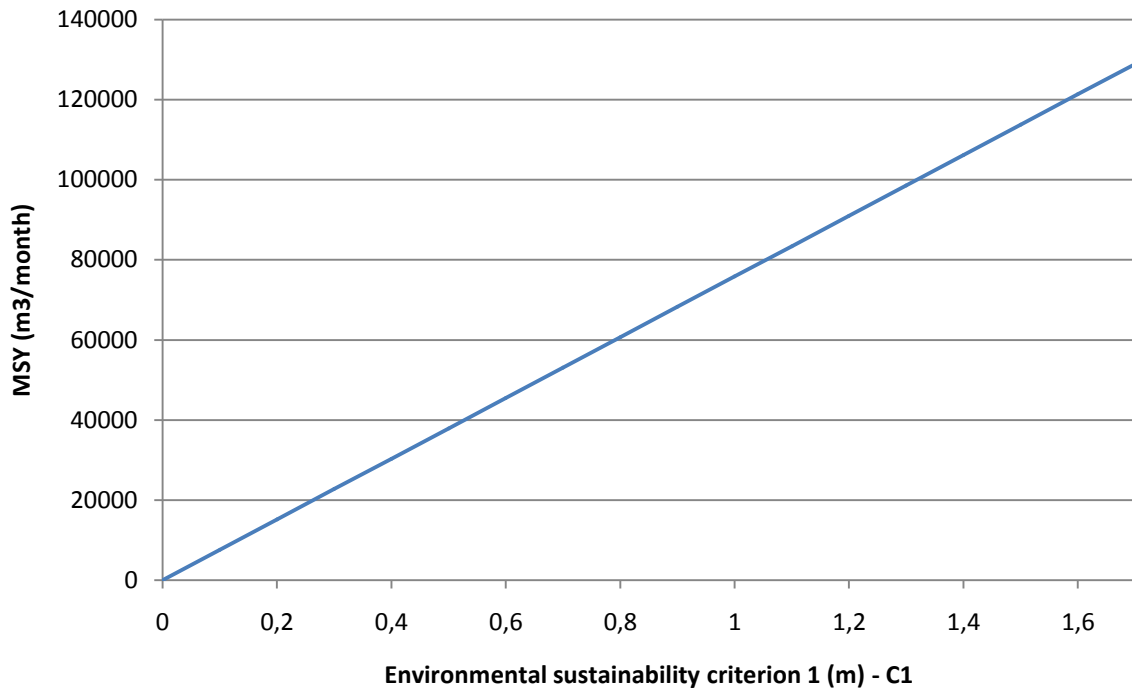

Figure 12: MSY related to variability of C1

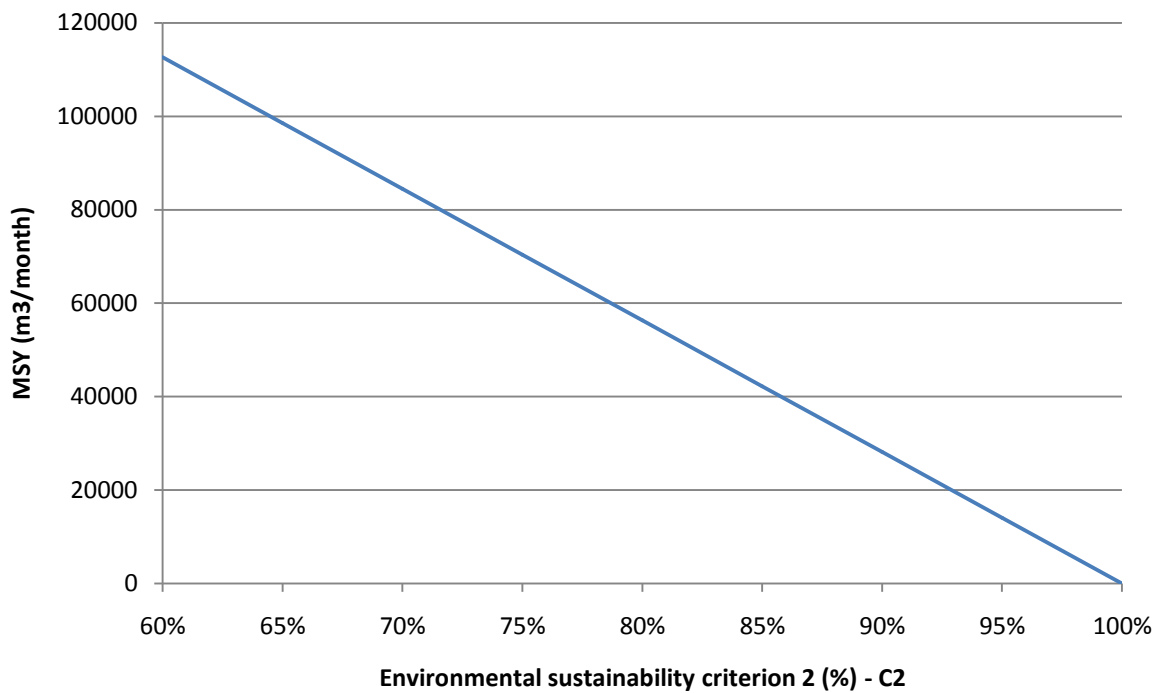

Figure 13: MSY related to variability of C2

The graphs (Figure 8-Figure 13) presented in this paragraph shows that the natural recharge is not related to MSY-1, and is positive linear related to MSY-2. The level on non linearity is positive non linear related to MSY-1, and not related to MSY-2. The surface area is positive linear related to MSY-1 and MSY-2. The residence time is negative non linear related to MSY-1, and not related to MSY-2.

Environmental sustainability criterion 1 is positive linear related to MSY-1. Environmental sustainability criterion 2 is negative linear related to MSY-2.

### 3.1.7 Sensitivity analysis of MSY

The sensitivity of the maximum sustainable yield on parameter variability for both criteria is investigated here. All the parameters are scaled by dividing the value with its default value defined in paragraph 3.1.2. Therefore, it is possible to present the variability of the six parameters in one graph. The effect of parameter variability on the MSY according to C1 and C2 are presented in Figure 14 and Figure 15.

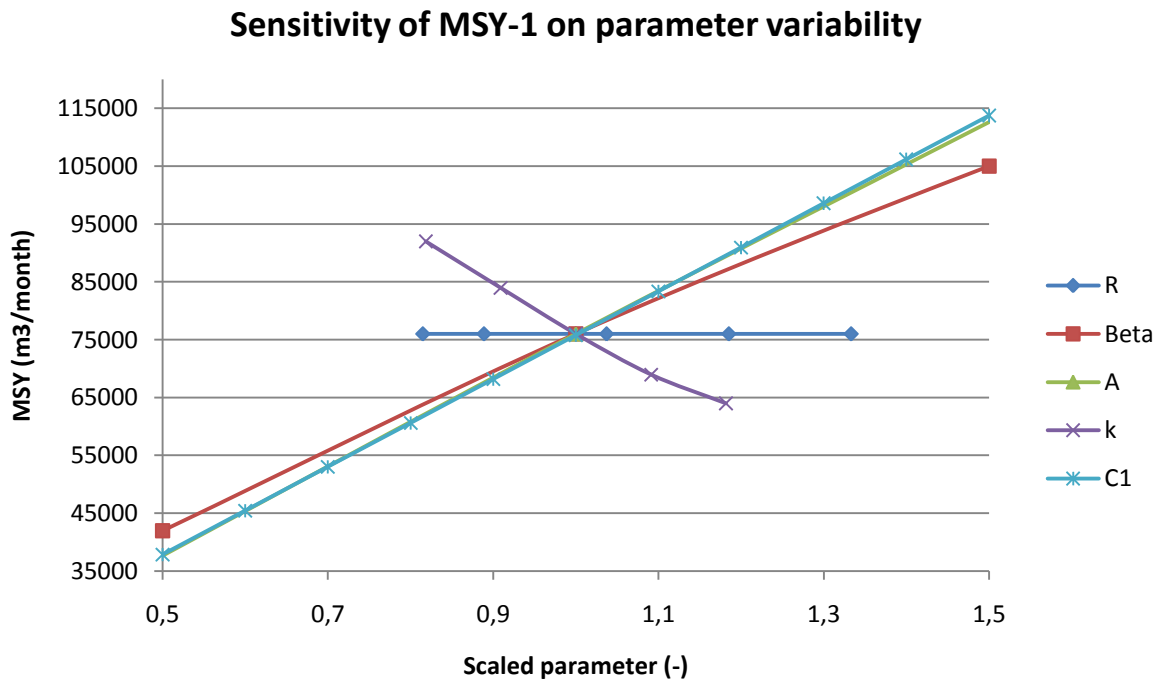

Figure 14: Sensitivity of MSY on parameter variability for C1



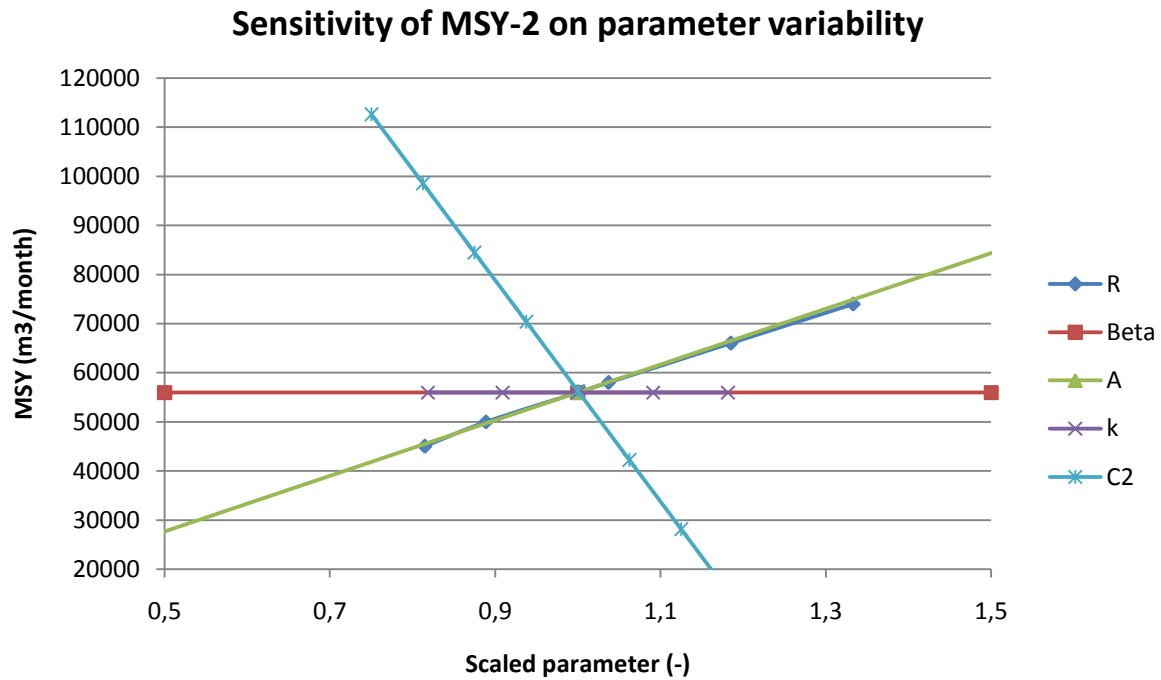

Figure 15: Sensitivity of MSY on parameter variability for C2

Figure 14 and Figure 15 show that the variability of environmental sustainability criteria are causing the highest changes in the maximum sustainable yield. Hereafter the surface area of the aquifer is most affecting the MSY. Two remarkable phenomena are that variability in recharge does not affect MSY-1 and variability in Beta and the residence time does not affect MSY-2.

### 3.1.8 Tipping line of the environmental sustainability criteria

In Figure 14 and Figure 15 it is clearly visible how changes in the environmental sustainability criteria affect the maximum sustainable yield. The tipping points, where the decisive criterion changes from one to the other one are interesting. Graphs are created with the relation between both environmental criteria for where the maximum sustainable yield is the same for both criteria. Furthermore, the effect of variability of the remaining four parameters is investigated on this relationship. Figure 16 clearly shows which criterion is decisive for a given combination of criteria in these particular circumstances.

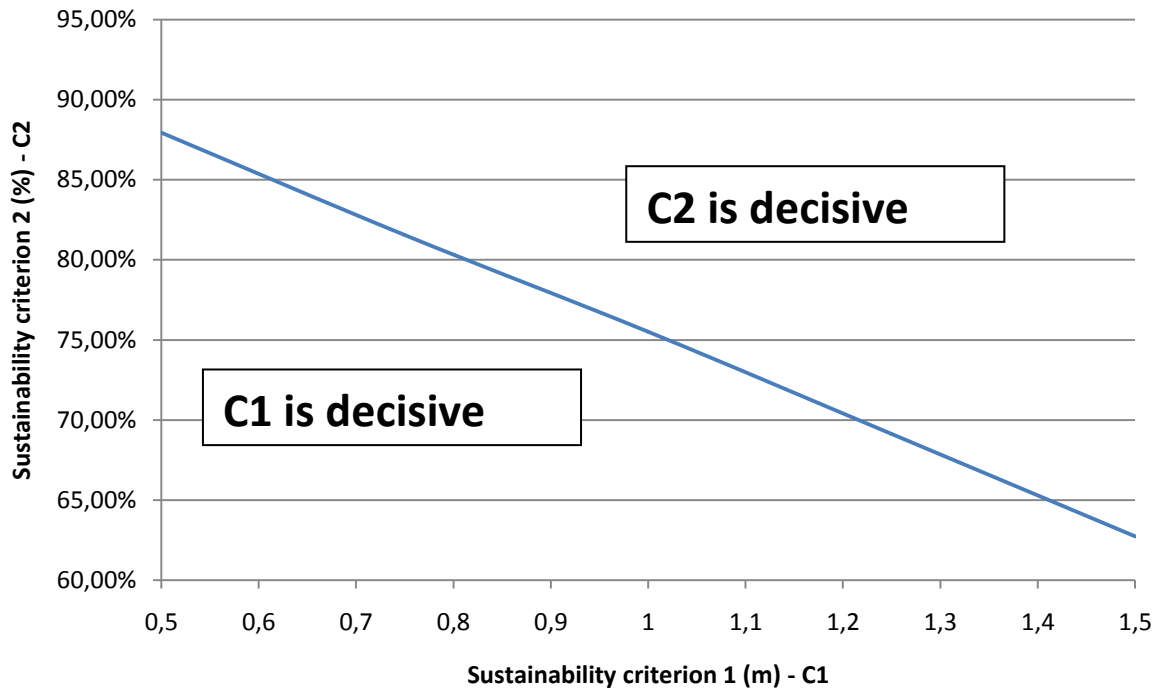

Figure 16: Relation between C1 and C2 for groundwater

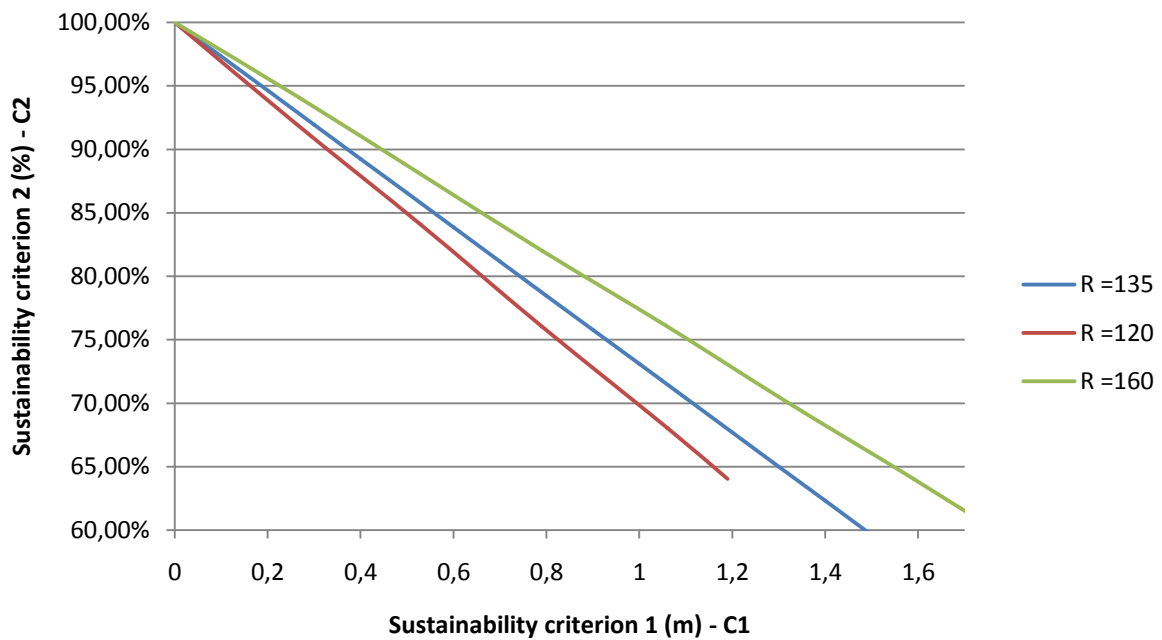

Figure 17: Relation between C1 and C2 for varying recharge values

If the natural recharge increases then more water is coming in the system, which will increase the equilibrium level of the stock. A maximum groundwater level drawdown of 1 meter is stricter for aquifers that has a higher depth, this will cause a higher chance of C1 becoming the decisive criterion.

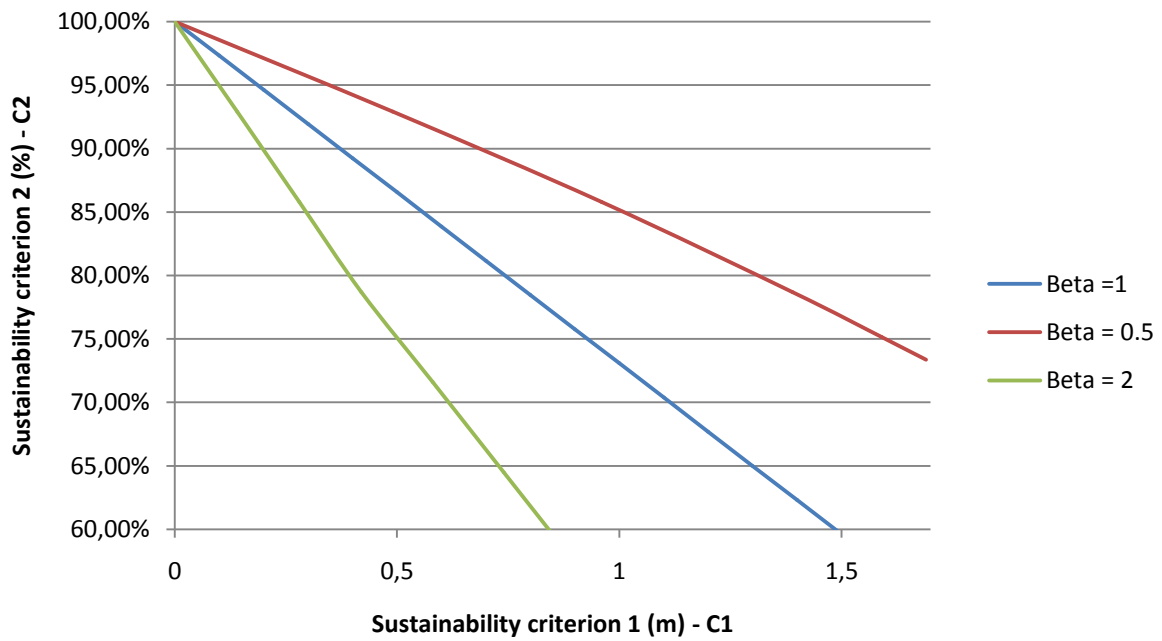

Figure 18: Relation between C1 and C2 for varying beta values

If the level of non linearity increases, then water is flowing faster to the river. This will result in that abstractions will decline the stock slower, and therefore the chance that C2 is becoming decisive increases.

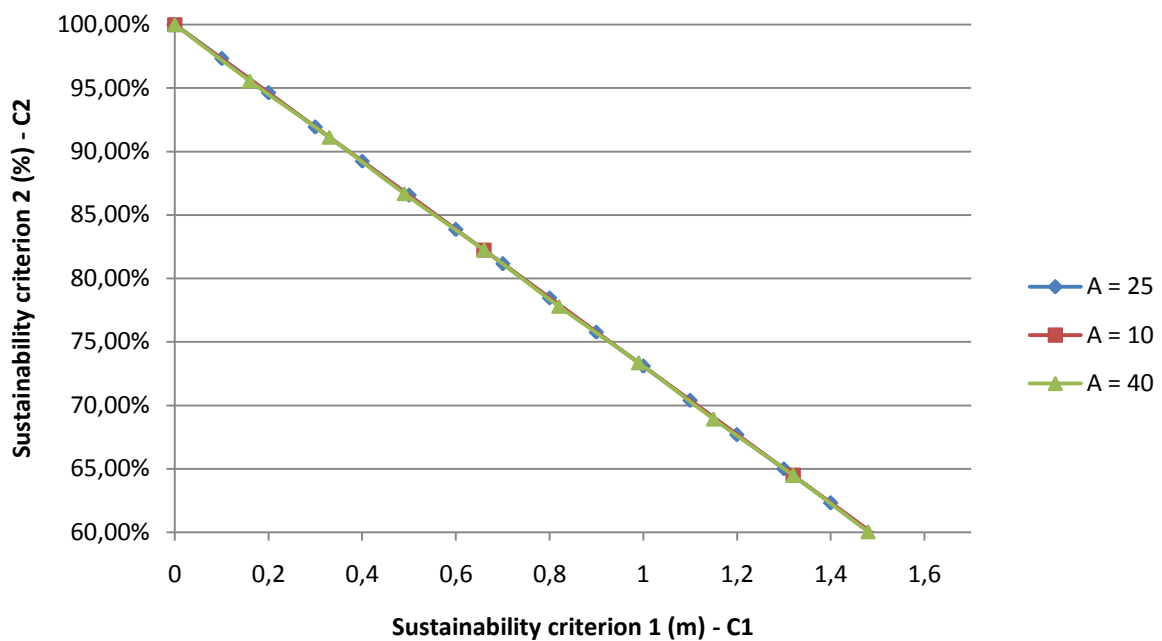

Figure 19: Relation between C1 and C2 for varying values of the surface area

Changes in surface area will influence the amount of water that is present in the system. However, it does not change the decisiveness of the environmental sustainability criteria, because both criteria are affected at the same rate by it.

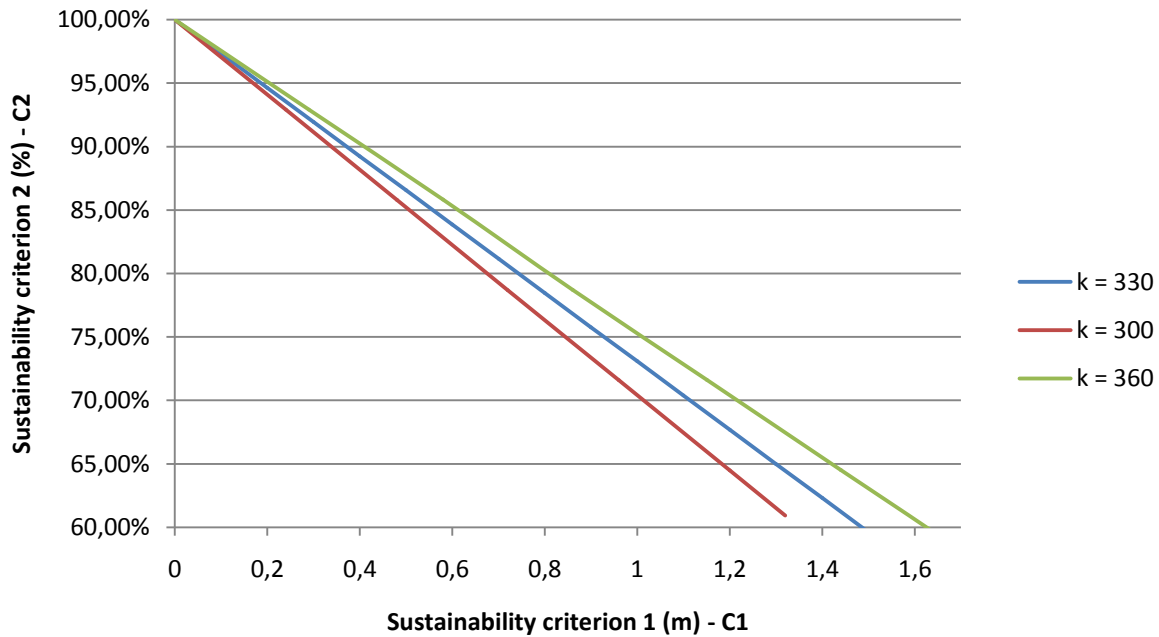

Figure 20: Relation between C1 and C2 for varying values of the residence time

If the residence time of a groundwater system increases, which means that the system responds slower, and less water will flow out to the river. then the chance that sustainability criterion 1 is decisive increases.

By changing parameters also the gradient of the tipping lines are changing. Let us consider the optimal case for where the sustainability criteria are chosen such that the MSY is equal according to both environmental criteria (tipping line) and that this is also the desired case. Then these two rules apply:

1. For greater gradients (steeper) of the tipping line applies that a change in sustainability criterion 2 will lead to a smaller allowable change in sustainability criterion 1 and change in sustainability criterion 1 will lead to a larger allowable change in sustainability criterion 2.
2. For smaller gradients (flatter) of the tipping line applies that change in sustainability criteria 2 will lead to a larger allowable change in sustainability criterion 1 and change in sustainability criterion 1 will lead to a smaller allowable change in sustainability criterion 2.

The question if the maximum sustainable yield is affected by a change in one of parameters depends on the starting conditions. As can be concluded from the tipping line investigation there are three possibilities for starting conditions. 1) Environmental criterion 1 is decisive for the determination of the maximum sustainable yield; 2) Environmental criterion 2 is decisive for the determination of the maximum sustainable yield; 3) the maximum sustainable yield is determined by both criteria. The next statements are the conclusions of how the maximum sustainable yield changes by changing the circumstances of the groundwater model.

#### **Environmental criterion 1 is decisive for the determination of the maximum sustainable yield**

- Increasing the natural recharge does not affect the MSY. Decreasing the natural recharge has no influence on the MSY until C2 becomes decisive.
- Increasing the level of non linearity will increase the MSY until C2 becomes decisive. Decreasing the level of non linearity will decrease the MSY.

- Increasing the surface area will increase the MSY and when C2 becomes decisive, the MSY will increase slower. Decreasing the surface area will decrease the MSY.
- Increasing the residence time will decrease the MSY. Decreasing the residence time will increase the MSY until C2 becomes decisive.
- Increasing the environmental sustainability criterion 1 will increase the MSY until C2 becomes decisive. Decreasing the environmental sustainability criterion 1 will decrease the MSY.

#### Environmental criterion 2 is decisive for the determination of the maximum sustainable yield

- Increasing the natural recharge will increase the MSY until C1 becomes decisive. Decreasing the natural recharge will decrease the MSY.
- Increasing the level of non linearity will not affect the MSY. Decreasing the level of non linearity will not affect the MSY until C1 becomes decisive.
- Increasing the surface area will increase the MSY. Decreasing the surface area will decrease MSY and when C1 becomes decisive the MSY will decrease faster.
- Increasing the residence time will not affect the MSY and when C1 becomes decisive, the MSY will decrease. Decreasing the MSY will not affect the MSY.
- Increasing the environmental sustainability criterion 2 will decrease the MSY. Decreasing the environmental sustainability criterion 2 will increase the MSY until C1 becomes decisive.

#### The maximum sustainable yield is determined by both criteria.

- Increasing the natural recharge will not affect the MSY. Decreasing the natural recharge will decrease the MSY.
- Increasing the level of non linearity will not affect the MSY. Decreasing the level of non linearity will decrease the MSY.
- Increasing the surface will increase the MSY with the rate that is determined by C2. Decreasing the surface area will decrease the MSY with the rate that is determined by C1.
- Increasing the residence time will decrease the MSY. Decreasing the residence time will not affect the MSY.
- Increasing the environmental sustainability criterion 1 will not affect the MSY. Decreasing the environmental sustainability criterion 1 will decrease the MSY.
- Increasing the environmental sustainability criterion 2 will decrease the MSY. Decreasing the environmental sustainability criterion 2 will not affect the MSY.

### 3.1.9 Feedback to reality

Figure 21 shows how the water table and natural discharge is affected by groundwater abstraction for the Cateauguay river aquifer (Gleeson et al., 2012). From zero to approximately 35  $\text{Mm}^3/\text{year}$  the data is available, and the rest is simulated with a model. The current pumping rate will cause a drawdown of 1.5 meters. Lavigne, Nastev, & Lefebvre (2010) argues that for the Chateauguay river aquifer the estimated sustainable limit is 48  $\text{Mm}^3/\text{year}$ , which will cause a water table drawdown of 2.2 meters. This estimated sustainability limit is equal to the defined maximum natural discharge criterion of 80% in our investigation. However the dimensions of the aquifers used in this case study are much larger than in our model and therefore C1 (maximum drawdown) is hard to compare with aquifers in reality.

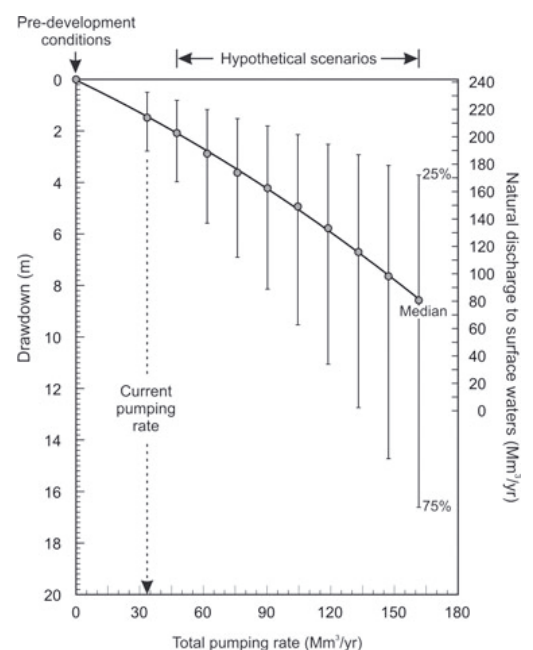

Figure 21: Chateauguay River aquifers

### 3.2 Biomass in a forest model

The next model consist of a forest that contain a volume of biomass. Biomass will grow due to photosynthesis, but can also die by a natural cause (disease, shortage of sunlight/water etc.). Dead biomass will naturally degrade due to bacteria and nutrients. Humans are abstracting biomass for using the wood for example to build houses or create energy. The surface area is not included in this model, because all the quantities are named per hectare.

#### 3.2.1 Model set up

The system diagram presented in Figure 22, shows how the model works.

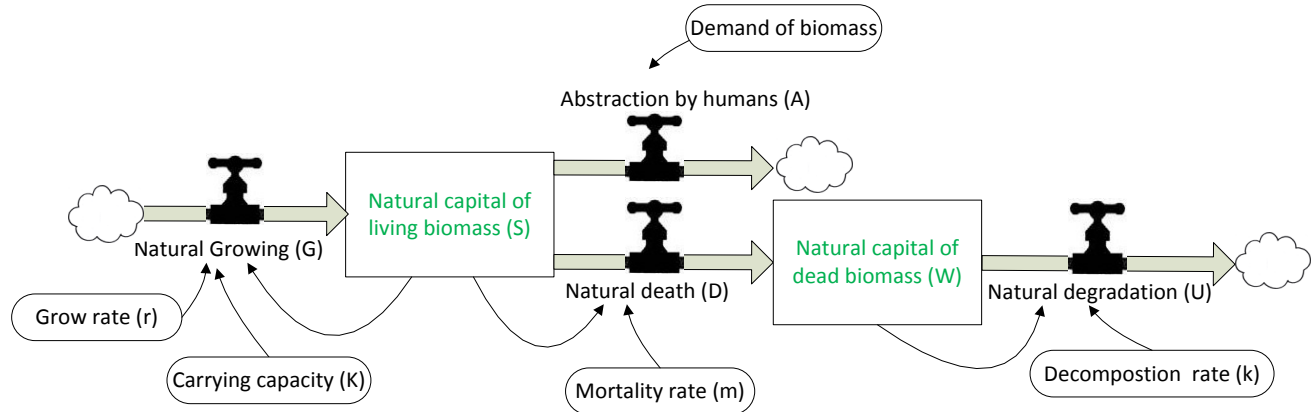

Figure 22: systems diagram of biomass in a forest

The model uses the next equations, which will be further explained in this paragraph.

$$\frac{dS}{dt} = G - A - D$$

$$\frac{dW}{dt} = D - U$$

$$G = r * S * \left(1 - \frac{S}{K}\right)$$

$$S_{eq} = K - \frac{K * m}{r}; (A = 0)$$

$$S_{eq} = \frac{(r - m) + \sqrt{(-r + m)^2 - \frac{4rA}{K}}}{\frac{2 * r}{K}}; (A \neq 0)$$

$$D = m * S$$

$$U = k * W$$

$$W_{eq} = \frac{m * S_{eq}}{k}$$

$$A = \text{variable}$$

Where,

S = the total natural capital of the volume of living biomass in the forest ( $\text{m}^3/\text{ha}$ );

W = the total natural capital of the volume of dead biomass in the forest ( $\text{m}^3/\text{ha}$ )

G = the natural growing process of biomass ( $\text{m}^3/\text{year}/\text{ha}$ );

r = the grow rate of biomass ( $\text{year}^{-1}$ );

K = the carrying capacity of the forest ( $\text{m}^3/\text{ha}$ );

D = Natural deaths of biomass ( $\text{m}^3/\text{year}/\text{ha}$ );

m = mortality rate of biomass ( $\text{year}^{-1}$ );

U = degradation process of dead wood by micro organism ( $\text{m}^3/\text{year}/\text{ha}$ );

k = The decomposition rate of dead wood ( $\text{year}^{-1}$ ).

The equation that is used for the growth of biomass is called the logistic growth equation. Though this formula is not used for calculating the total biomass in a forest in any paper, it is often used to calculate the biomass growth of a single tree (Botkin, Janak, & Wallis, 1972)(Bugmann, 2001). Also in other literature the growth of biomass in a forest is presented as a s-curve corresponding the logistic growth formula (Pretzsch, 2010). Therefore this equation is used that represents biomass growth in the model.

The Natural death of biomass is assumed to be a certain percentage of the total biomass. This is also supported by different papers (Acker et al., 2014)(Swaine, Lieberman, & Putz, 1987). The mortality rate often varies between 0 and 3 per cent per year. This however, does not include the abstraction by humans but is death of biomass due to natural causes.

Decay of dead biomass is often calculated with the exponential decay equation (Jonsson, Kruys, & Ranius, 2005)(Tobin, Black, McGurdy, & Nieuwenhuis, 2007). This equation is commonly in the form of:

$$W = W_0 * e^{-kt}$$

Which is the solution of the equation that is used in the model.

The decomposition rate k determines how fast the volume of dead biomass is decaying over time. Chambers, Higuchi, Schimel, Ferreira, & Melack (2000) reviewed the decomposition rates of globally distributed eco systems used by other authors. The decomposition rates ranges from 0.01 to 0.2 in their study. Apparently, the decomposition rate depends a lot on specie type and location. However decomposition rates between 0.1 and 0.2 are quite rare. Hahn & Christensen (2004) are using decay rates between 0.02 and 0.1 for European forests. They also came to a relation between dead wood volume and living wood volume for different forest types, wherefore our default volumes of living and dead biomass seems quite normal.

### 3.2.2 Initial conditions and assumptions

To model a forest with biomass, it is necessary to make assumptions and set the initial conditions.

- The calculations and numbers that are given are all per hectare;
- The initial volume of living biomass that is present in the forest is  $875 \text{ m}^3$  per hectare;
- The carrying capacity is  $1000 \text{ m}^3$  per hectare (Pretzsch, 2010 p. 434);
- The runtime of the model is 750 years;
- The grow rate is assumed to be 0.08 and the mortality rate is assumed to be 0.01 (Acker et al., 2014);
- The decomposition rate of dead wood is assumed to be 0.06 (Chambers et al., 2000);

- The volume of living biomass that is abstracted by humans to produce for example energy or build houses is assumed to be constant in time;
- The initial volume of dead wood is  $145.83 \text{ m}^3$  per hectare which is in equilibrium with the volume of living biomass.
- The natural recruitment and grow process of biomass is merged to one inflow entity.

### 3.2.3 Results

In this model there are two stocks, whereas stock 2 is depending on stock 1. The first results of how this system responds to a yield disturbance are given in Figure 23, Figure 24 and Figure 25.

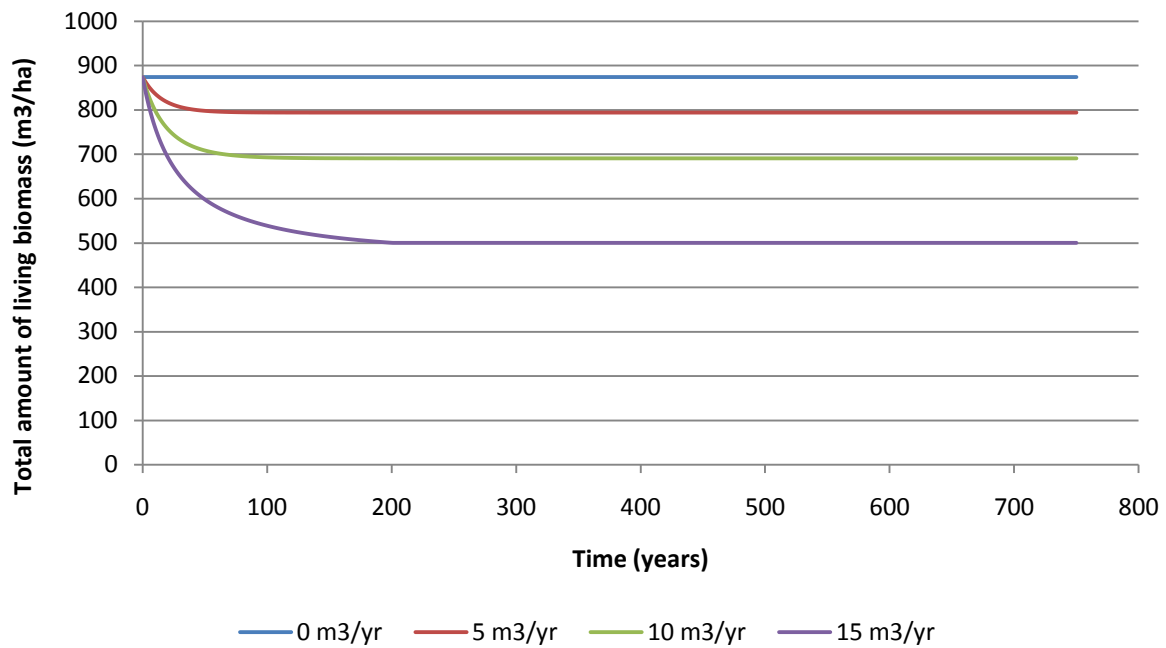

Figure 23: Relation between the volume of biomass and different abstraction intensities



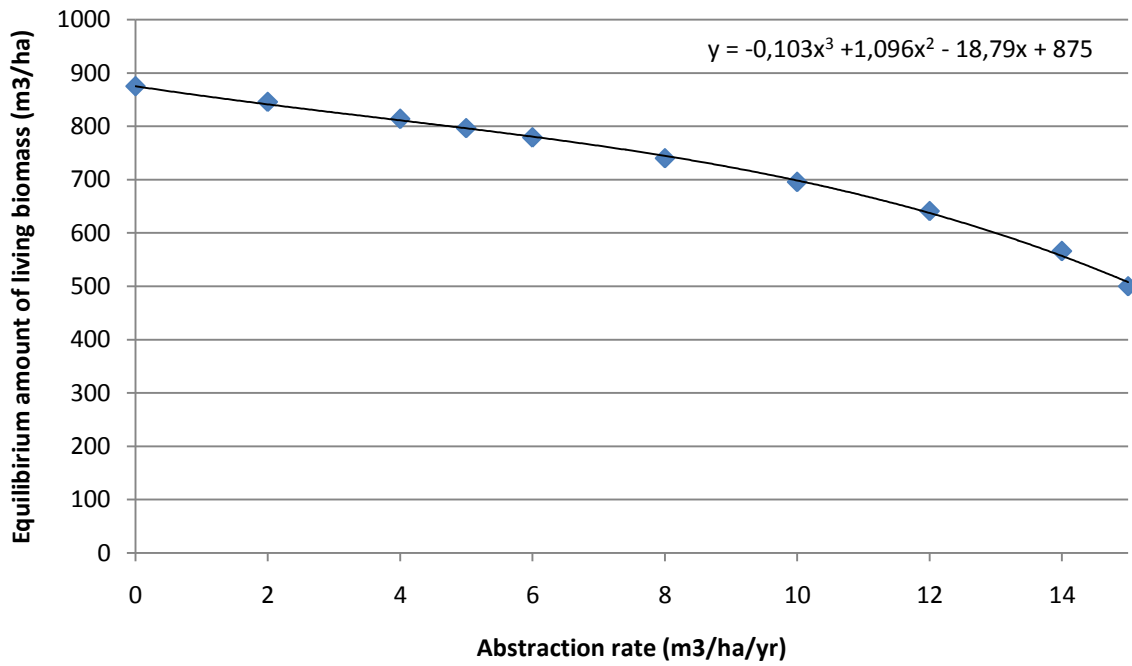

Figure 24: Relation between the equilibrium volume of biomass and the abstraction intensity

What immediately is noticeable about Figure 24 and Figure 25 is that it shows a nonlinear relationship in contradiction to the groundwater model. For both figures a third grade polynomial trend line is added to calculate what the maximum sustainable yield is for a given criterion.

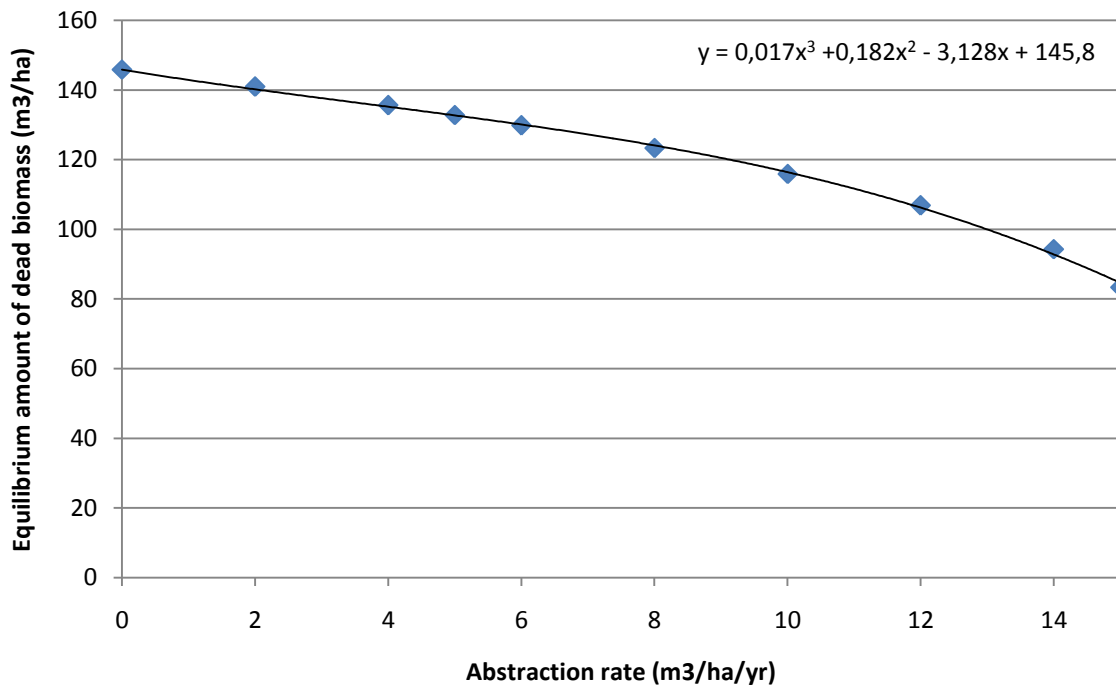

Figure 25: Relation between the equilibrium volume of dead biomass and the abstraction intensity

### 3.2.4 Environmental sustainability criteria

Sustainability of biomass in a forest can be indicated by the biodiversity of the forest (Hahn & Christensen, 2004). According to the literature this biodiversity can be measured on the basis of two indicators. The first indicator is the natural capital of living biomass in the forest. There is much literature available on the sustainability of forest eco systems and many authors are explaining why it is important to set sustainability thresholds. However, hardly anybody is actually setting a concrete threshold for the reduction of the natural capital of biomass in forests. Though Angelstam & Törnblom (2004) is arguing that the acceptable loss of habitat in European forests should be between 10 and 30 per cent in his papers (Angelstam & Törnblom, 2004)(Angelstam, Breuss, & Mikusinski, 2001). Beyond a 30 per cent loss of habitat, viable populations are unable to maintain their numbers. Assuming that the habitat corresponds to the volume of living biomass in a forest, this can be translated to a concrete threshold for the natural capital of biomass.

#### **Environmental sustainability criterion 1 (C1): Minimum natural capital of living biomass: 80% of the natural equilibrium.**

The threshold value of 80 per cent is not considered as a fixed value, but is one of the parameters.

The second indicator for biodiversity in a forest is the volume of dead biomass in a forest (Radu, 2006)(Bütler, Angelstam, Ekelund, & Schlaepfer, 2004). Müller & Bütler (2010) investigated the volume of dead biomass in a forest as a critical environmental variable. They argue that there is a strong correlation between the volume of dead biomass and the biodiversity in European forests. Finally, they conclude that it is necessary to establish several forest stands with dead biomass volumes of  $> 20 - 50 \text{ m}^3$  per hectare. On average the volume of dead biomass in a forest can vary between 15 and 37 per cent of the living volume of biomass (Hahn & Christensen, 2004). The environmental sustainability criterion will be formulated a deviation from the equilibrium situation.

#### **Environmental sustainability criterion 2 (C2): Maximum reduction in the volume of dead biomass: $40 \text{ m}^3$ of the natural equilibrium per hectare.**

Again the threshold value is not considered as a fixed value, but as a parameter.

Note that C1 is a relative criterion and C2 is a absolute reduction criterion. The maximum allowable reduction will change for C1 for changing values of the volume of living biomass, while for C2 this maximum allowable reduction stays the same for changing volumes of dead biomass. Another thing that should be noted is that both environmental sustainability criteria are stock related.

### 3.2.5 Maximum sustainable yield

The maximum sustainable yield (MSY) is defined as the volume of biomass that can be harvested without violating one of the two environmental sustainability criteria set in the previous paragraph. For the first criterion the maximum sustainable yield can be easily determined with the help of Figure 24 and the trend line equation. Solving the equation will give a maximum sustainable yield according to criterion 1 of  $9.77 \text{ m}^3$  per hectare per year. The maximum sustainable yield according to environmental sustainability criterion 2 can be calculated with the help of Figure 25 and the trend line equation given. The maximum sustainable yield according to this criterion is  $11.88 \text{ m}^3$  per hectare per year. For the default values of parameters used, the maximum sustainable yield on the basis of environmental sustainability criterion 1 is decisive, because this criterion is violated first. Hereafter the MSY according to C1 is called MSY-1, and the MSY according to C2 is called MSY-2.

### 3.2.6 Investigation of parameter variability on MSY

In the previous paragraph assumptions were made to come to the results that are presented in the graphs. In this paragraph the effect of changed circumstances on the maximum sustainable yield is investigated. The next parameters are considered as the circumstances of the environmental system.

- Grow rate  $r$  ( $\text{yr}^{-1}$ );
- Mortality rate  $m$  ( $\text{yr}^{-1}$ );
- The carrying capacity  $K$  ( $\text{m}^3/\text{ha}$ );
- The decomposition rate  $k$  ( $\text{yr}^{-1}$ );
- Environmental sustainability criterion 1  $C1$  (%);
- Environmental sustainability criterion 2  $C2$  ( $\text{m}^3/\text{ha}$ );

Parameter	$r$ ( $\text{yr}^{-1}$ )	$m$ ( $\text{yr}^{-1}$ )	$K$ ( $\text{m}^3/\text{ha}$ )	$k$ ( $\text{yr}^{-1}$ )	$C1$ (%)	$C2$ ( $\text{m}^3/\text{ha}$ )
Range	0.04-0.12	0.005-0.03	600-1400	0.04-0.1	60-100	0-60
Default value	0.08	0.01	1000	0.06	80	40

Table 2: Biomass in a forest model parameters

It will be investigated how the variability of one single parameter affect the maximum sustainable yield without changing any of the other parameters. By changing the parameters, it often happens that the equilibrium situation of  $875 \text{ m}^3$  living biomass and  $145.8 \text{ m}^3$  of dead biomass changes also. This will be shown in a separate table.  $S_{eq}$  is the equilibrium situation of the living biomass and  $W_{eq}$  is the equilibrium situation of the dead biomass. The equilibrium situation is the situation without human abstraction. The results of the graphs are explained further in the paragraph.

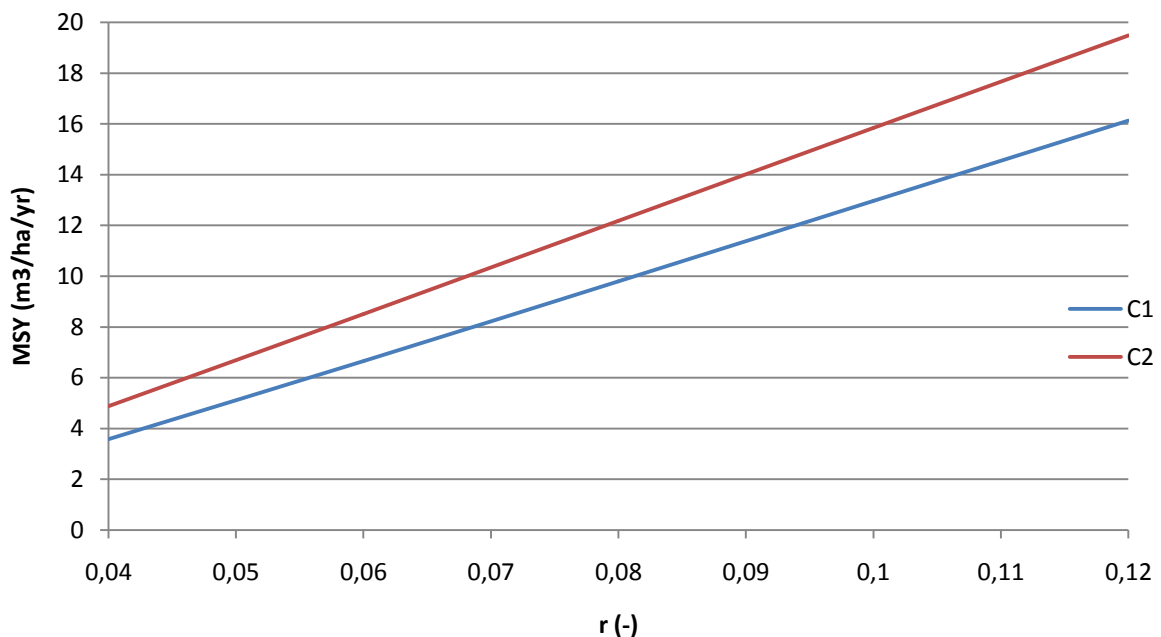

Figure 26: MSY related to variability of the grow rate

r	0.04	0.06	0.08	0.1	0.12
$S_{eq}$	750	833.33	875	900	916.7
$W_{eq}$	125	138.89	145.83	150	152.78

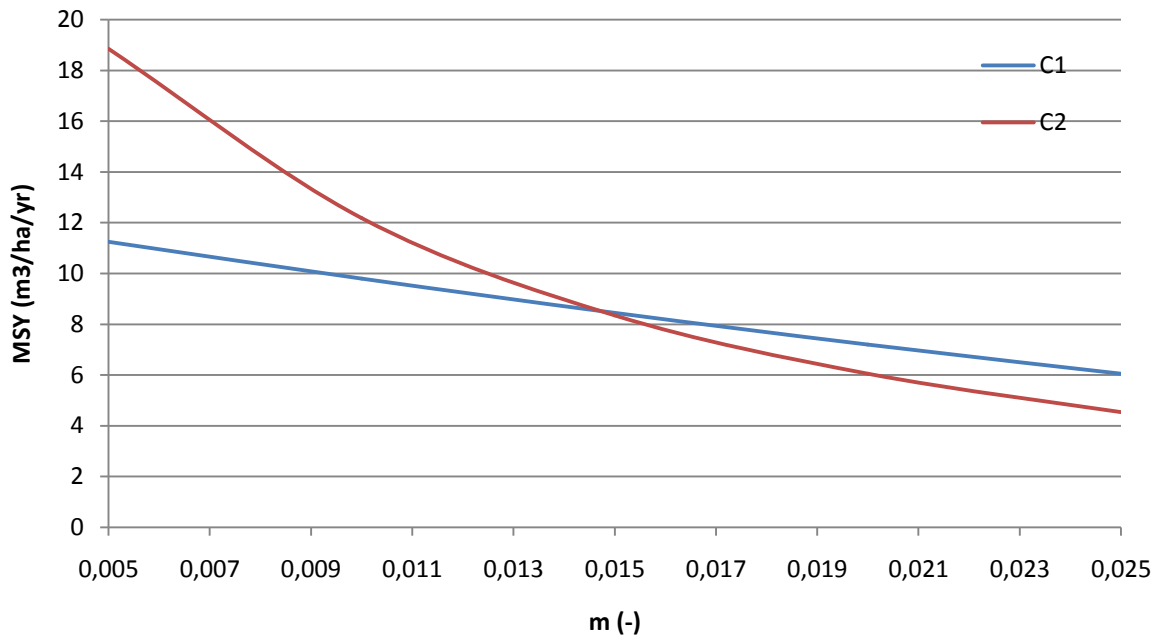

Figure 27: MSY related to variability in mortality rate

m	0.005	0.01	0.015	0.02	0.025
Seq	937.5	875	812.5	750	687.5
Weq	78.13	145.83	203.13	250	286.46

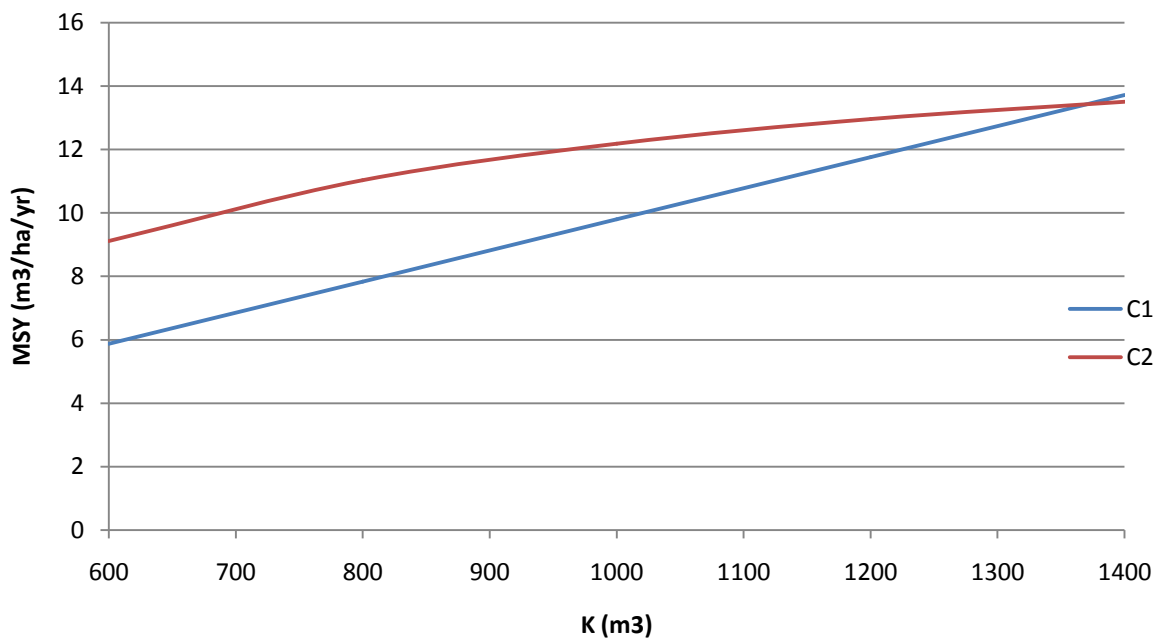

Figure 28: MSY related to variability of the carrying capacity

K	600	800	1000	1200	1400
Seq	525	700	875	1050	1225
Weq	87.5	116.67	145.83	175	204.17

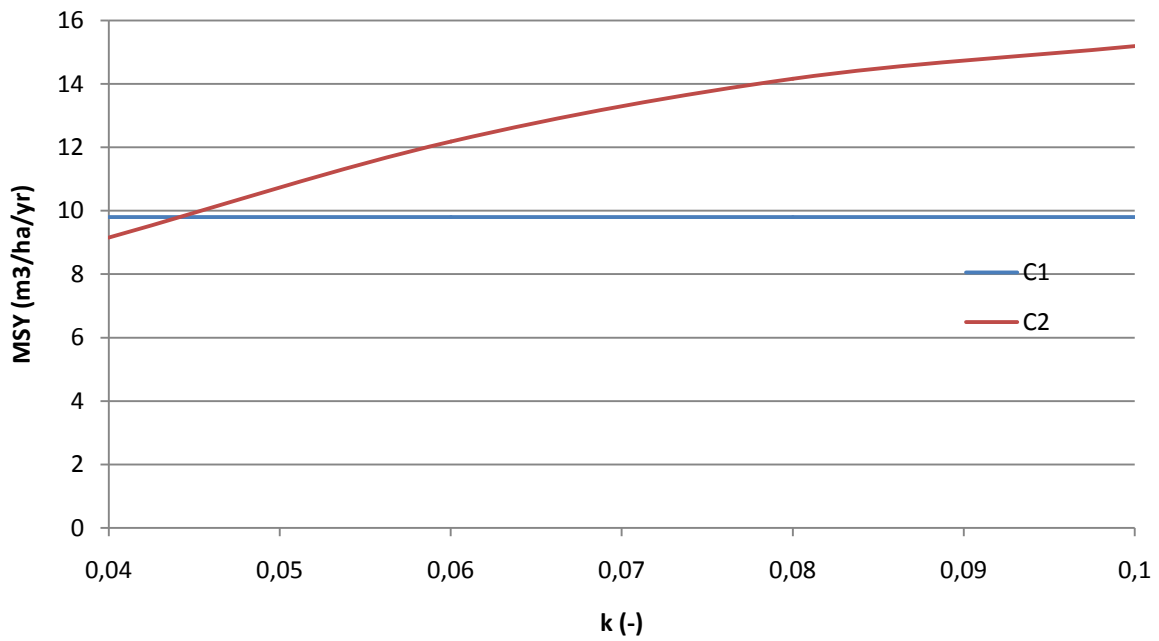

Figure 29: MSY related to variability of the decomposition rate

k	0.04	0.06	0.08	0.1
Seq	875	875	875	875
Weq	218.75	145.83	109.38	87.5

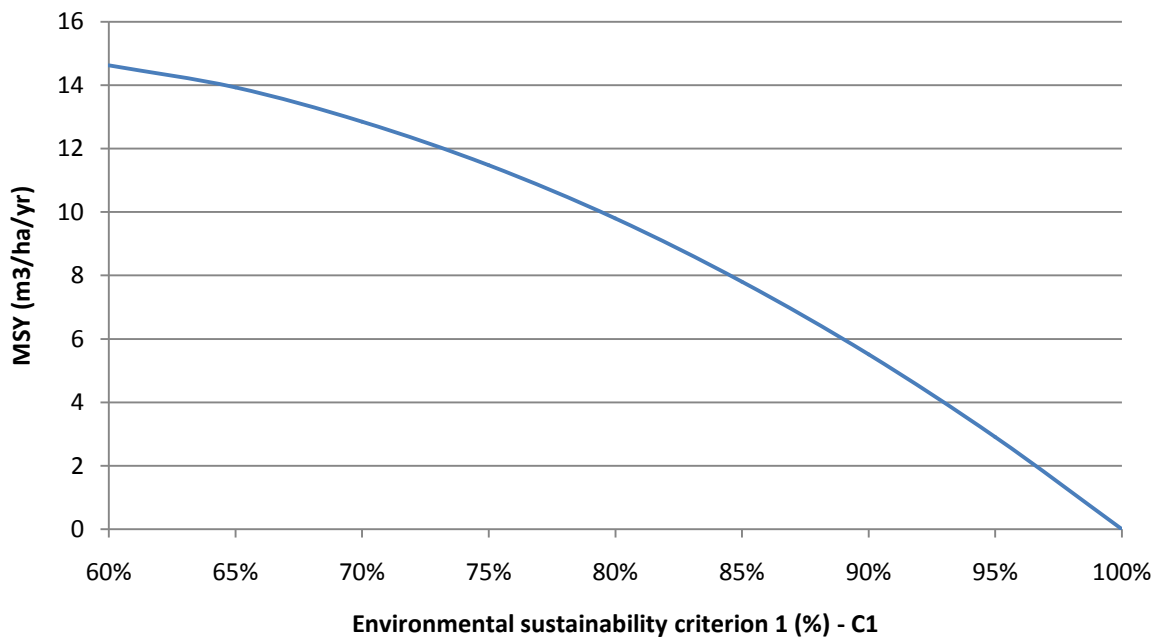

Figure 30: MSY related to variability of C1

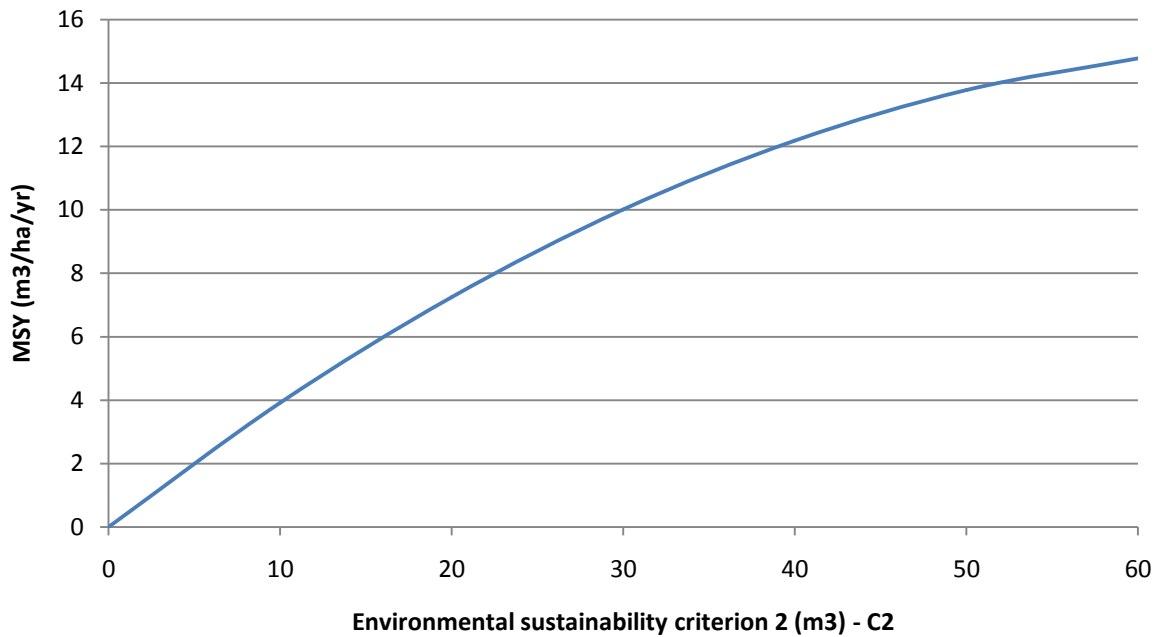

Figure 31: MSY related to variability in C2

From the graphs (Figure 26-Figure 31) that are presented in this paragraph it can be concluded that the natural growth rate is positive linear related to MSY-1 and MSY-2. The mortality rate is negative linear related to MSY-1, and negative non linear related to MSY-2. The carrying capacity is positive linear related to MSY-2, and positive non linear related to MSY-2. The decomposition rate is not related to MSY-2, and positive non linear related to MSY-2. Environmental sustainability criterion 1 is negative non linear related to MSY-1. Environmental sustainability criterion 2 is positive non linear related to MSY-2.

A remarkable thing is that the four parameters ( $r$ ,  $m$ ,  $K$ ,  $k$ ) investigated in this paragraph are all linearly related to MSY-1, except for the decomposition rate. And that the four parameters are all non linear related to MSY-2. This probably has to do with the fact that C1 is a relative criterion and C2 an absolute reduction criterion.

### 3.2.7 Sensitivity Analysis of MSY

In this sensitivity analysis the variability of all parameters are scaled by dividing the parameter by its default value set in the previous paragraph. Therefore, a graph can be plotted with the variability of all parameters for environmental sustainability criterion 1 and 2. For Figure 32 and Figure 33 applies that the higher the gradient of the line, the more sensitive the MSY is on changes in that parameter.

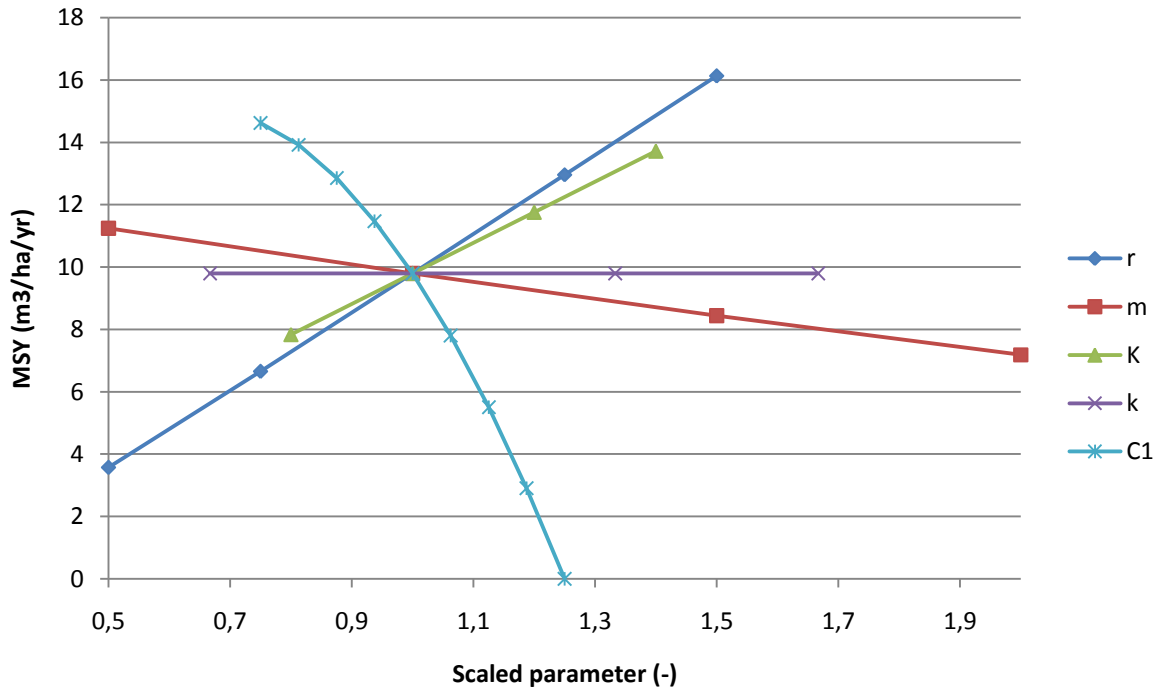

Figure 32: Sensitivity of MSY on parameter variability for C1

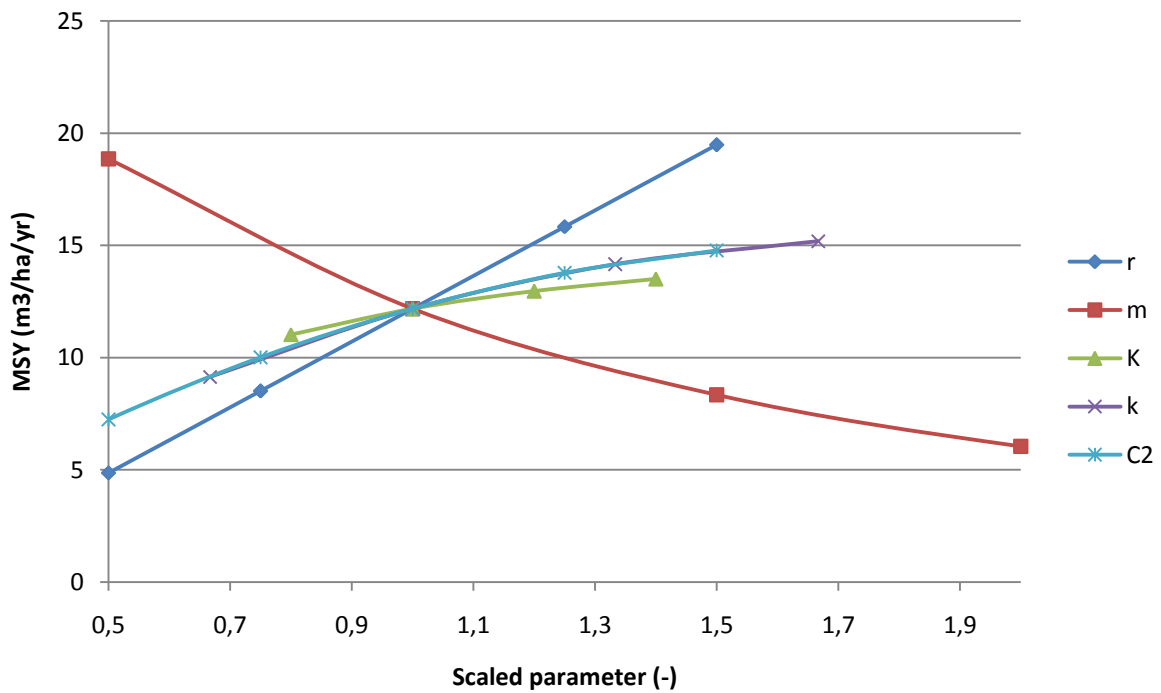

Figure 33: Sensitivity of MSY on parameter variability for C2

Figure 32 and Figure 33 show that MSY-1 is most sensitive to changes in sustainability criterion 1 and MSY-2 is most affected by variability in grow rate. A typical difference between the groundwater model and this model is that there are much more non linear relationships between MSY and

parameter variability, while for the groundwater model the majority were linear relationships. Variability in decomposition rate is the only parameter that is not affecting MSY-1 and all parameters are influencing the MSY-2.

### 3.2.8 Tipping line of the environmental sustainability criteria

The tipping line where the decisive criterion changes from C1 to C2 or from C2 to C1 is investigated here. The graphs presented in this chapter will clearly give an indication what criterion is decisive in a specific circumstance. Also the variability of the remaining four parameters on this tipping line is investigated. The vertical axis presents the environmental sustainability criterion one, which implies the minimum natural capital of biomass in percentage of its original value. The horizontal axis presents the environmental sustainability criterion two, which implies the maximum reduction in dead wood in cubic meters per hectare.

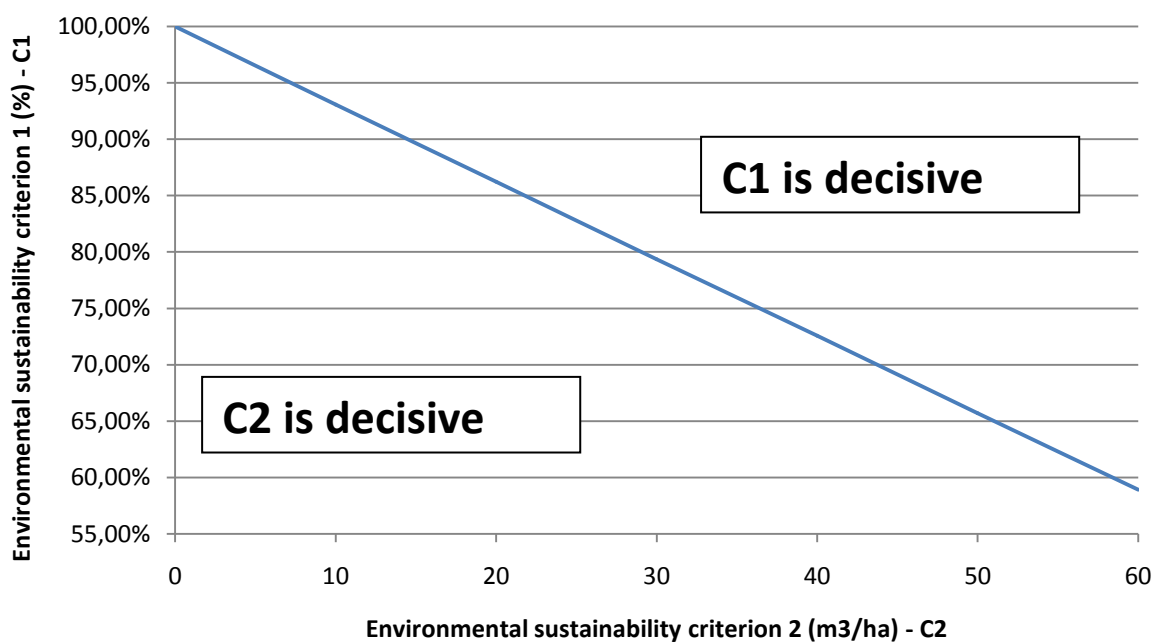

Figure 34: Relation between C1 and C2 for biomass in a forest



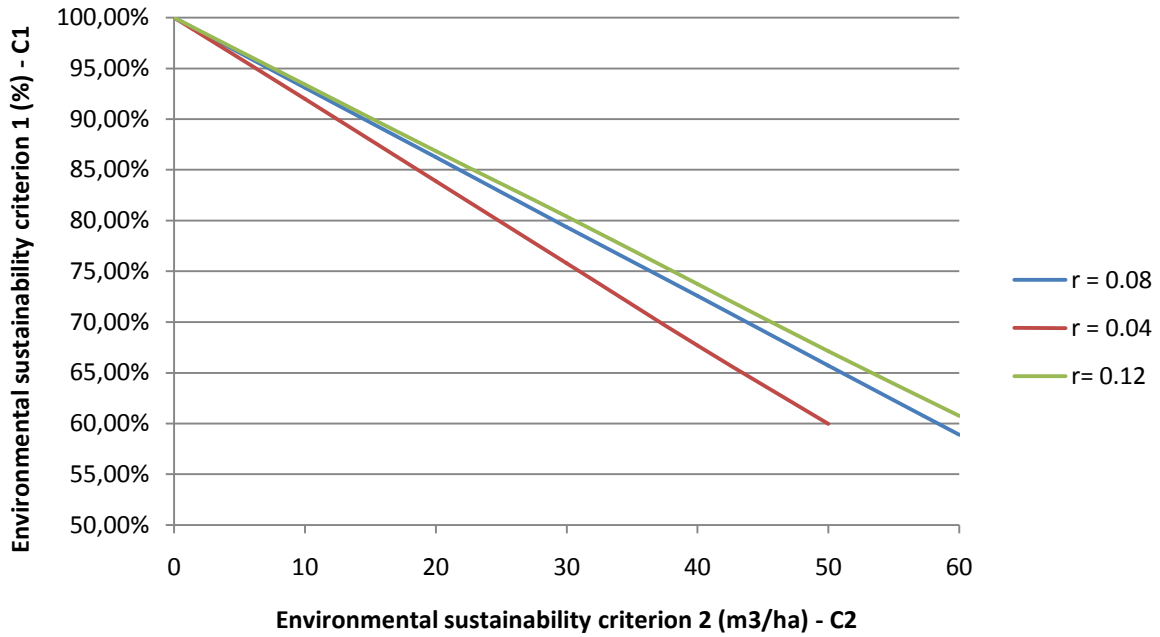

Figure 35: Relation between C1 and C2 for varying grow rates

If the natural grow rate increases, then biomass will grow faster. Also the Equilibrium volume of living and dead biomass is increased. The chance that C2 becomes the decisive criterion increases very slightly.

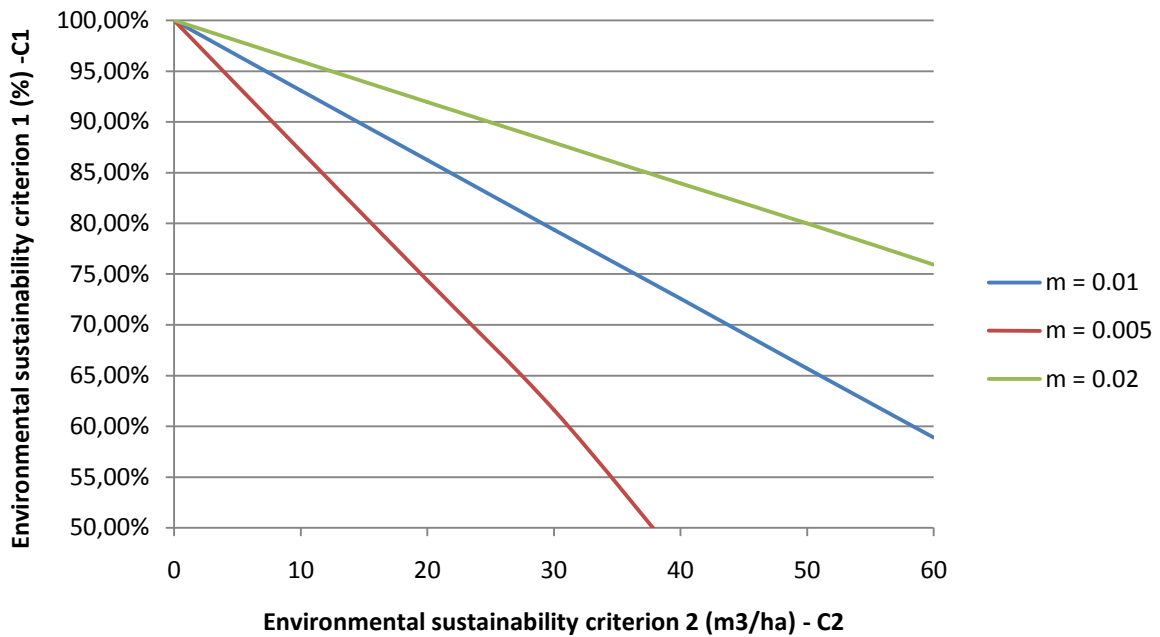

Figure 36: Relation between C1 and C2 for varying mortality rates

Increasing the mortality rate will result in more dead biomass per year. Therefore the equilibrium volume of living biomass will decrease while the equilibrium volume of dead biomass will increase. This will increase the chance that C2 becomes the decisive criterion largely.

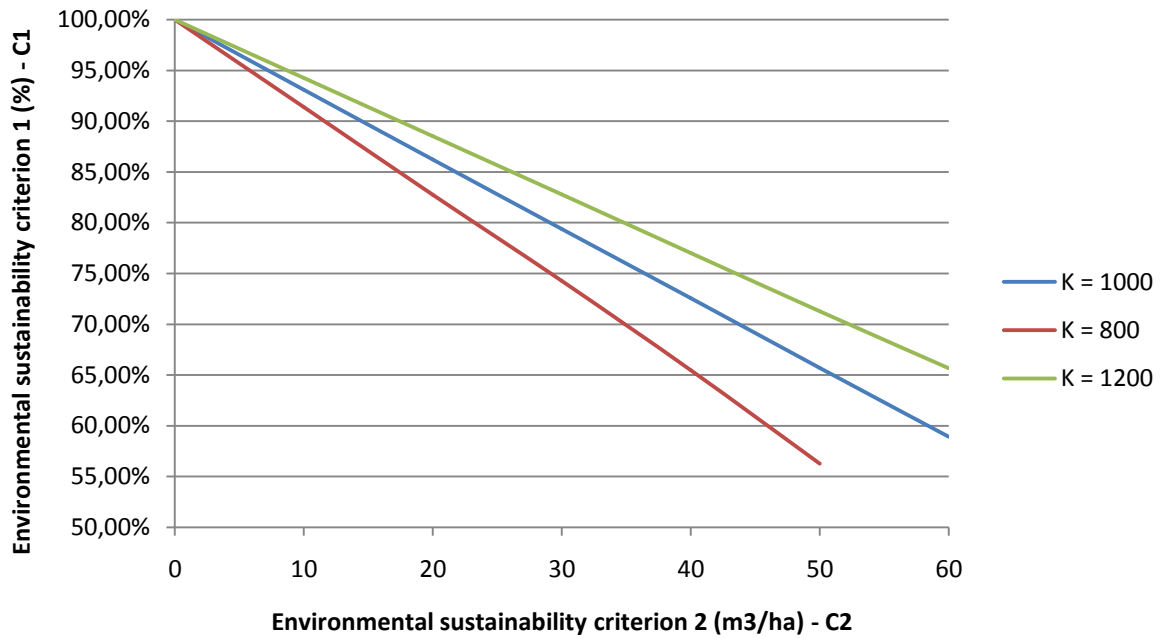

Figure 37: Relation between C1 and C2 for varying carrying capacities

Increasing the carrying capacity of the forest means that the forest is capable of maintaining more biomass per hectare. This will thus increase the equilibrium volume of living biomass in the forest. Since the natural capital of dead biomass is a function of the natural capital of living biomass, also the equilibrium volume of dead biomass will increase. This means that the chance that C2 is the decisive criterion increase considerably.

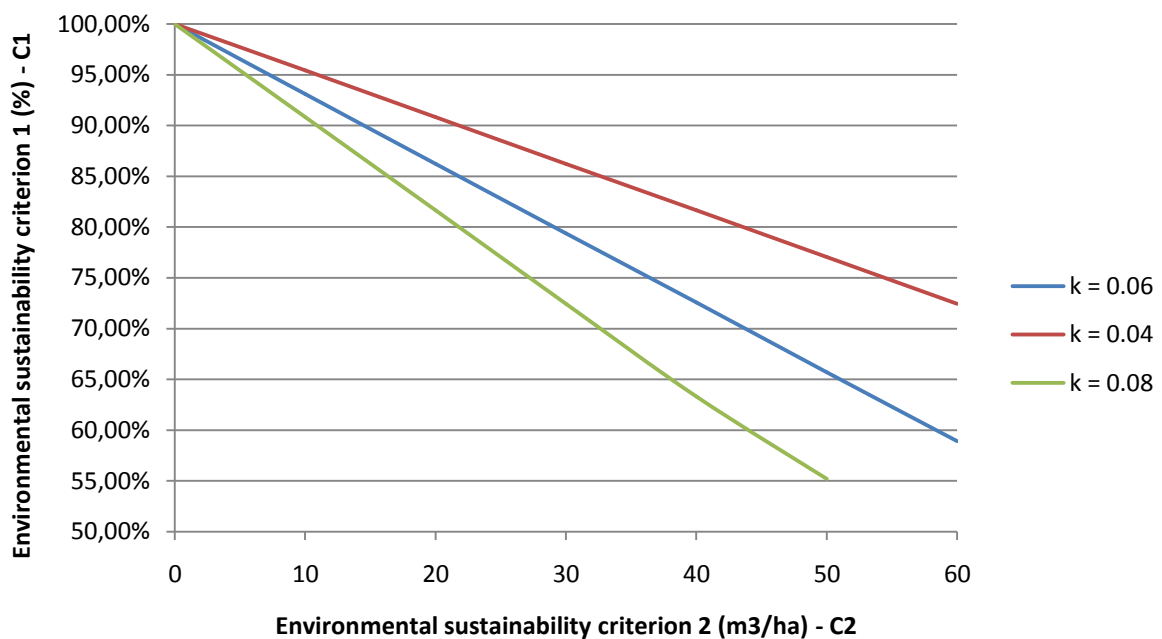

Figure 38: Relation between C1 and C2 for varying decomposition rates

Increasing the decomposition rate will increase the decay of dead biomass. Therefore, the equilibrium volume of dead biomass will decrease. This will result in an considerable increased chance of C1 becoming the decisive criterion.

The two rules about the gradient of the tipping line that are set in the groundwater model does also apply on this model. However both sustainability criteria should be reversed. This is caused by the fact that also the axes are reversed.

In general, it can concluded that increasing the parameters will increase the chance that C2 becomes decisive and decreasing the parameters will increase the chance that C1 becomes decisive. For the changes in decomposition rates this is vice versa.

Also the biomass in a forest model knows three starting conditions. How the maximum sustainable yield is affected by parameter variability depends on these starting conditions.

#### **Environmental criterion 1 is decisive for the determination of the maximum sustainable yield**

- Increasing the natural grow rate will increase the MSY and when C2 becomes decisive it will increase with a slightly lower gradient. Decreasing the natural grow rate will decrease the MSY.
- Increasing the mortality rate will decrease the MSY. Decreasing the mortality rate will increase the MSY.
- Increasing the carrying capacity of the forest will increase the MSY and when C2 becomes decisive it will increase further but with a declining gradient. Decreasing the carrying capacity will decrease the MSY and when C2 becomes decisive it will decrease further with an increasing gradient
- Increasing the decomposition rate of deadwood will not affect the MSY. Decreasing the decomposition rate will also not affect the MSY until C2 becomes decisive. The MSY will then decrease with an increasing gradient.
- Increasing the environmental sustainability criterion 1 will decrease the MSY. Decreasing the environmental sustainability criterion 1 will increase the MSY with a declining gradient until C2 becomes decisive.

#### **Environmental criterion 2 is decisive for the determination of the maximum sustainable yield**

- Increasing the natural grow rate will increase the MSY. Decreasing the natural grow rate will decrease the MSY and when C1 becomes decisive it decrease with a higher gradient.
- Increasing the mortality rate will decrease the MSY with a declining gradient and when C1 becomes decisive it will decrease with a constant gradient. Decreasing the mortality rate will increase the MSY with an increasing gradient and when C1 becomes decisive it will increase with a constant gradient.
- Increasing the carrying capacity of the forest will increase the MSY with a declining gradient. Decreasing the carrying capacity will decrease the MSY with an increasing gradient.
- Increasing the decomposition rate of deadwood will increase the MSY until C1 becomes decisive. Decreasing the decomposition rate will decrease the MSY with an increasing gradient.
- Increasing the environmental sustainability criterion 2 will increase the MSY until C1 becomes decisive. Decreasing the environmental sustainability criterion 2 will decrease the MSY.

**The maximum sustainable yield is determined by both criteria.**

- Increasing the natural grow rate will increase the MSY with the rate that is determined by C2. Decreasing the natural grow rate will decrease the MSY with the rate that is determined by C1.
- Increasing the mortality rate will decrease the MSY with the rate that is determined by C2. However at some point this rate is again determined by C1 (when the MSY determined by C1 is lower than the MSY determined by C2). Decreasing the mortality rate will increase the MSY with the rate that is determined by C1.
- Increasing the carrying capacity of the forest will increase the MSY with a rate that is determined by C2. Decreasing the carrying capacity of the forest will decrease the MSY with a rate that is determined by C1. However at some point this rate is again determined by C2.
- Increasing the decomposition rate will not affect the MSY. Decreasing the decomposition rate will decrease the MSY with a rate that is determined by C2.
- Increasing the environmental sustainability criterion 1 will decrease the MSY. Decreasing the environmental sustainability criterion 1 will not affect the MSY.
- Increasing the environmental sustainability criterion 2 will not affect the MSY. Decreasing the environmental sustainability criterion 2 will decrease the MSY.

**3.2.9 Feedback to reality**

Most of the case studies in literature are taking diameter at breast height (dbh) and cutting cycles into account in their studies (Kammesheidt, Kohler, & Huth, 2001). Kammesheidt et al. (2001) came to the conclusion that only 60 year cutting cycles provided sustainable yields of respectively 30-60 m<sup>3</sup> per hectare per cycle for forests in Venezuela. In the most optimistic case this would result in 1 m<sup>3</sup>/ha/year, which is much lower than the sustainable yields in our study. Furthermore a lot of research has been done about the sustainability of forests in the world, however, hardly anybody comes with real numbers of the maximum sustainable yield values in cubic meters per hectare per year. Though in the Congo basin 1-2 trees are being logged per hectare per year, which is equal to 8-12 m<sup>3</sup> per hectare per year (Karsenty & Gourlet-Fleury, 2006) depending on tree type. These values are closer to the values that are used in this model.

### 3.3 Pollution in Lake model

The third model is a lake that is connected to an inflow channel and an outflow channel. Furthermore, a pollution source is depositing a certain amount of pollutants in the lake. The pollutants are removed naturally by for example plankton, settling processes etc. Higher concentrations of the pollutants in the lake may cause eutrophication, which may lead to undesired deaths of for example fish. Therefore maximum tolerable concentrations are defined. The surface area of the lake is 500 by 500 meters and the average depth is 4 meters. This brings the total volume of the lake to 1000,000 cubic meters.

#### 3.3.1 Model set up

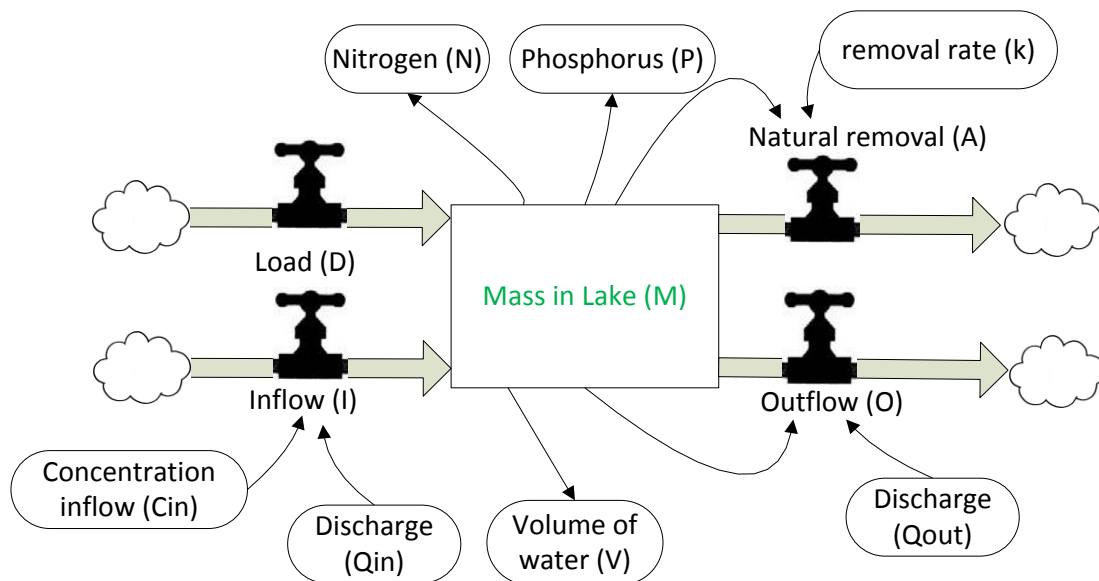

Figure 39: Flow stock diagram of pollution in a lake

The equations that are used in this model are shown below.

$$\frac{dM}{dt} = I + D - A - O$$

$$M = N + P$$

$$I = Q_{in} * c_{in}$$

$$Q = Q_{in} = Q_{out}$$

$$D = \text{variable}$$

$$O = Q_{out} * \frac{M}{V}$$

$$A = k * M$$

$$M_{eq} = \frac{D + Qc_{in}}{\frac{Q}{V} + k}$$

Where,

M = the total mass of pollutants in the lake (kg);

N = total mass of nitrogen (kg);

P = total mass of phosphorus (kg);

I = The inflow of pollutants due to the natural inflow channel (kg/day);

$Q_{in}$  = the discharge of the inflow channel ( $m^3/day$ );

$C_{in}$  = concentration of pollutants in the inflow stream ( $kg/m^3$ );

D = Load of pollutants by a pollutant source (kg/day);

O = The outflow of pollutants due to the natural outflow channel (kg/day);

$Q_{out}$  = the discharge of the outflow channel ( $m^3/day$ );

V = the volume of water that is present in the lake ( $m^3$ );

A = Natural removal of the lake (kg/day);

k = removal rate ( $day^{-1}$ ).

One of the most simplest systems to model a natural water body is a completely mixed system (Chapra, 1997). The equations that are used in the model are all based on this completely mixed system described in the book of Chapra (1997).

The removal rate is the rate at which the pollution is removed from the lake. This removal rate depends on the type of pollution. For now the pollution is assumed to only consist of Nitrogen (N) and phosphorus (P). Nitrogen is broken down by bacteria or other organisms. McCarthy, Wynne, & Berman (1982) investigated this and searched for the uptake rate of dissolved nitrogen by microplankton in Lake Kinneret (Israel). They came to the conclusion that the uptake rate of Nitrate is  $1 - 40 * 10^{-4}$  per hour for Lake Kinneret. They further compared the uptake rate with other lakes. From this comparison you can conclude that there is actually a wide range of nitrogen uptake rates for different lakes. The uptake rate mainly depends on how much plankton (bacteria) are present to break down the pollution. The removal of Phosphorus is mainly caused by the settling of plankton (Havens & Schelske, 2001). The settling loss rate can be approximated with the Vollenweider equation (Chapra, 1997):

$$k = \frac{10}{H}$$

Where H is the mean depth of the lake. Using this equation would lead to a settling loss rate of  $0.0068 day^{-1}$ . However, according to the simplest seasonal approach for modeling phosphorus the range of the settling loss rate is between  $0.0125$  and  $0.15 day^{-1}$  (Chapra, 1997). Islam et al. (2013) distinguished in their study the state of the pollutant, dissolved or particulate. Decomposition rates of dissolved forms were five-seven times higher than that of particulate forms in the rivers of Korea and the decomposition rates of phosphorus were higher than those of nitrogen. However, for simplicity the removal rate of nitrogen and phosphorus is assumed to be equal to each other which is  $20 * 10^{-4}$  per hour ( $0.048 day^{-1}$ ). This estimation also falls in the range of the particulate pollution forms (Islam et al., 2013)

In a report of the Dutch Rijksinstituut voor Volksgezondheid en milieu (RIVM) the background concentrations of nitrogen and phosphorus are estimated for the river Rhine. In this model, the background nitrogen and phosphorus concentration of the inflow channel is assumed to be equal to the estimated background concentrations in the river Rhine. For nitrogen this include  $0.6 mg L^{-1}$  ( $6 * 10^{-4} kg m^{-3}$ ) and for phosphorus  $0.05 mg L^{-1}$  ( $5 * 10^{-5} kg m^{-3}$ ) (Liere & Jonkers, 2002). The total concentration of pollution entering the lake is therefore assumed to be  $6.5 * 10^{-4} kg m^{-3}$  ( $C_{in}$ ). The NP ratio of the background concentrations is therefore 12 (12 parts nitrogen and 1 part phosphorus), which is assumed to be constant.

The variables volume of the lake and discharge of the in and outlet channel are not based on literature, because this is location and circumstances dependent.

### 3.3.2 Initial conditions and assumptions

The model of pollution in a lake is based on assumptions and initial conditions.

- The volume of water in the lake is constant in time  $Q_{in} = Q_{out}$ ;
- For simplicity reasons the pollution is assumed to only consist of nitrogen and phosphorus;
- Contamination only enters the lake from the inflow channel and the load of the pollution source;
- The volume of water in the lake is assumed to be 1 million  $m^3$  ( $500 \times 500 \times 4$ );
- The rate at which nutrients and bacteria break down the pollution is assumed to be  $0.048 \text{ day}^{-1}$ . Equal for phosphorus and nitrogen;
- Concentration of pollution of the inlet channel is assumed to be  $6.5 \times 10^{-4} \text{ kg/m}^3$ ;
- The discharge of the inlet channel is assumed to be  $1 \text{ m}^3/\text{s}$  ( $86400 \text{ m}^3/\text{day}$ );
- Removal processes only takes place in the lake;
- The model is based on a completely mixed system (no diffusion);
- The model runs for 365 days.

### 3.3.3 Results

The next figure shows how the total mass of pollution is changed over time for different load rates.

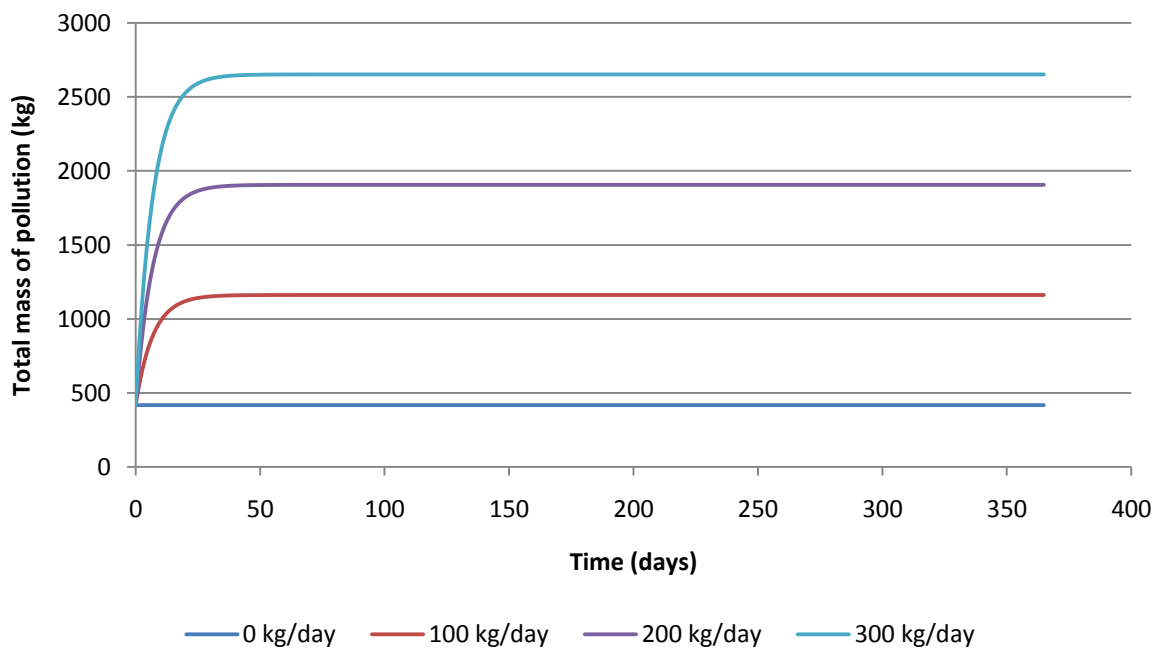

Figure 40: Relation between mass of pollution and load rates

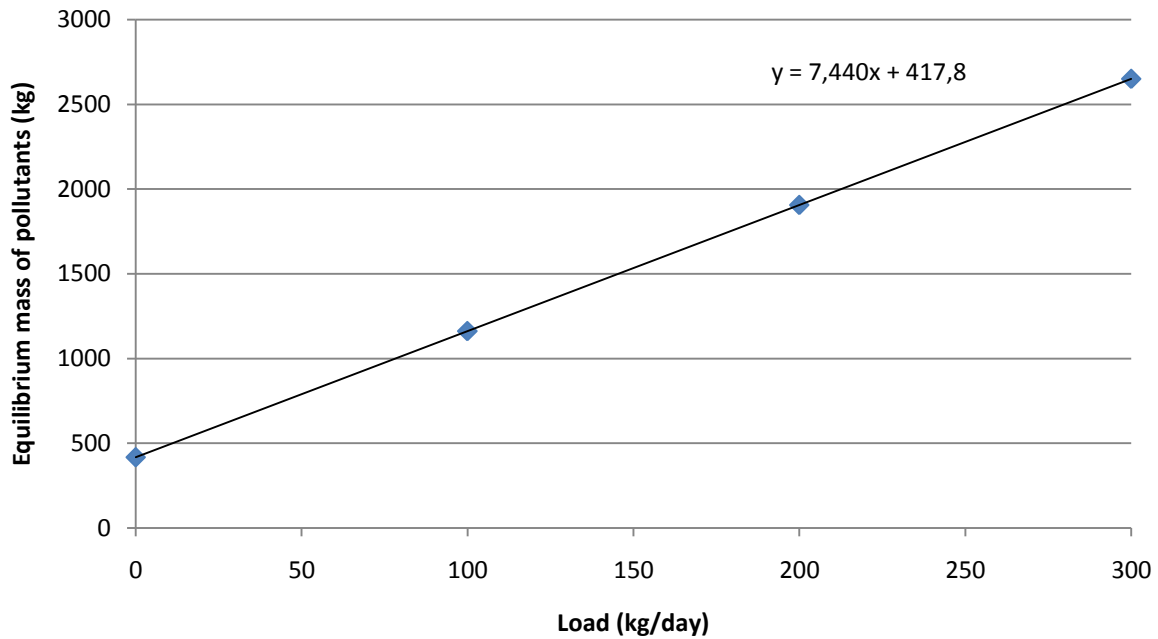

Figure 41: Relation between equilibrium amount mass of pollution and load rate

### 3.3.4 Environmental sustainability criteria

When it comes to the sustainability of load in a lake the critical load concept is often used (Bull, 1992). The critical load is the threshold of pollution concentration or load where below harmful undesired effects on sensitive elements of the eco system do not occur (OECD). Sometimes also the term maximum tolerable concentration (MTC) is used for the critical load of pollutants.

In the same document that estimated the background concentration for the Rhine river, also critical loads for a large Dutch lake called "Ijsselmeer" has been defined. The maximum tolerable concentrations of the Ijsselmeer are 0.15 milligrams phosphorus per liter and 2.2 milligrams of nitrogen per liter. Values of 0.05 milligrams phosphorus per liter and 1 milligram of nitrogen per liter have been set as a long term target values to combat eutrophication (Liere & Jonkers, 2002). In the document besluit kwaliteitseisen (2009) en monitoring water which is part of the Dutch law and regulations, maximum concentrations of organic bounded nitrogen and phosphate are defined for surface water which is used for human drinking purposes. The maximum concentrations for organic bounded nitrogen and phosphate includes  $2.5 \text{ mg L}^{-1}$  and  $0.3 \text{ mg L}^{-1}$  respectively.

The critical load of phosphorus is also supported by other papers. Janse et al. (2008) investigated the critical load of phosphorus for different types of shallow lakes with empirical evidences. The critical loads for phosphorus ranged from  $0.023 \text{ mg L}^{-1}$  to  $0.4 \text{ mg L}^{-1}$ .

For now the critical loads of nitrogen en phosphorus in our model are assumed to be the same as for the Ijsselmeer namely  $0.15 \text{ mg P L}^{-1}$  ( $1.5 \cdot 10^{-4} \text{ kg m}^{-3}$ ) and  $2.2 \text{ mg N L}^{-1}$  ( $2.2 \cdot 10^{-3} \text{ kg m}^{-3}$ ).

With the given dimensions of the modeled lake, a set up can be made of the environmental sustainability criteria in the form of mass of pollution:



**Environmental sustainability criterion 1 (C1): Maximum tolerable mass of Nitrogen: 2200 kg.**

**Environmental sustainability criterion 2 (C2): Maximum tolerable mass of Phosphorus: 150 kg.**

Both threshold values are not considered as a fixed value, but as a parameter. Both sustainability criteria are fixed absolute criteria in this model, because in literature all the critical loads mentioned are also absolute fixed criteria. Also both criteria are stock related in this model.

### 3.3.5 Maximum sustainable load

To determine the maximum sustainable load (MSL), considering the ratio of nitrogen and phosphorus of the deposited load is necessary. This is done by introducing a NP ratio of the deposited load. The NP ratio is the amount of mass of nitrogen that is equal to 1 unit of mass of phosphorus. The average NP ratio of potential nutrient sources of fresh water lakes varies from 0.1 to 247.4 depending on the pollution source (Downing & Mccauley, 1992). By assuming that our pollution source is a sewage, the average NP ratio varies between 2.8 and 10 (Downing & Mccauley, 1992). For now the pollution source is assumed to be a sewage with a NP ratio of 8. The MSL is the mass of nitrogen and phosphorus cumulative.

The MSL for both sustainability criteria can be determined with the help of Figure 42. The sum of both lines presented in Figure 42, will result in the line that is presented in Figure 41. The MSL according to C1 is called MSL-1 and the maximum sustainable load according to C2 is called MSL-2.

According to Figure 42 the MSL-1 is 274 kg/day and MSL-2 is 142 kg/day, which means that MSL-2 is decisive in this case.

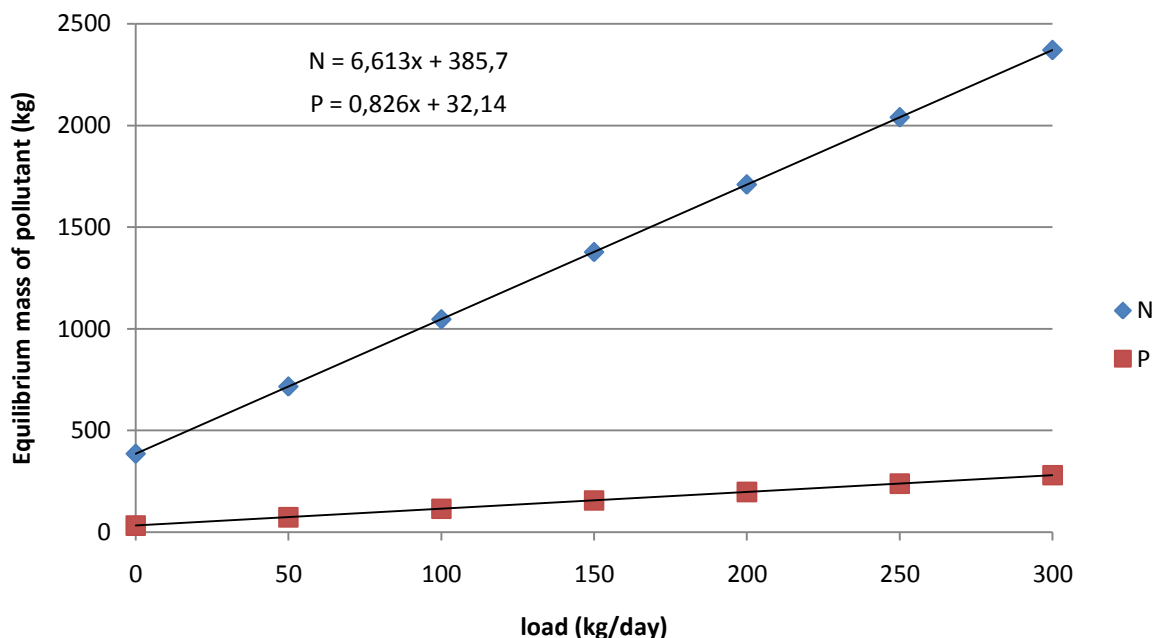

Figure 42: Relation between pollution mass of nitrogen and phosphorus and load intensity

### 3.3.6 Investigation of parameter variability on MSL

In this paragraph it is investigated how the MSL is affected when the values of certain parameters are changed. The parameters that will be investigated and their range are shown below:

- Discharge of the inflow and outflow channel  $Q$  ( $\text{m}^3/\text{day}$ );
- Removal rate  $k$  ( $\text{day}^{-1}$ );
- The NP ratio of the load (-);
- Pollution concentration of the inflow channel  $c_{\text{in}}$  ( $\text{kg}/\text{m}^3$ );
- Environmental sustainability criterion 1 C1 (kg);
- Environmental sustainability criterion 2 C2 (kg).

Parameter	$Q$ ( $\text{m}^3/\text{day}$ )	$k$ ( $\text{day}^{-1}$ )	NP ratio (-)	$c_{\text{in}}$ ( $\text{kg}/\text{m}^3$ )	C1 (kg)	C2 (kg)
Range	43200-172800	0.024-0.096	2-20	$3 \cdot 10^{-4}$	1000-3400	50-250
Default value	86400	0.048	8	$6.5 \cdot 10^{-4}$	2200	150

Table 3: Pollution in a lake model parameters

In this paragraph an investigation is done in how the MSL is changing for different values of one single parameter. By changing the parameters it might happen that the equilibrium value of the stock is also changed. The changes of the stock will be presented in tables below the graphs. Note that for the variability of the concentration of the inflow channel the total concentration of pollution is changed, wherefore the ratio of Nitrogen and Phosphorus of the background concentration stays the same (NP ratio of inflow channel is 12).

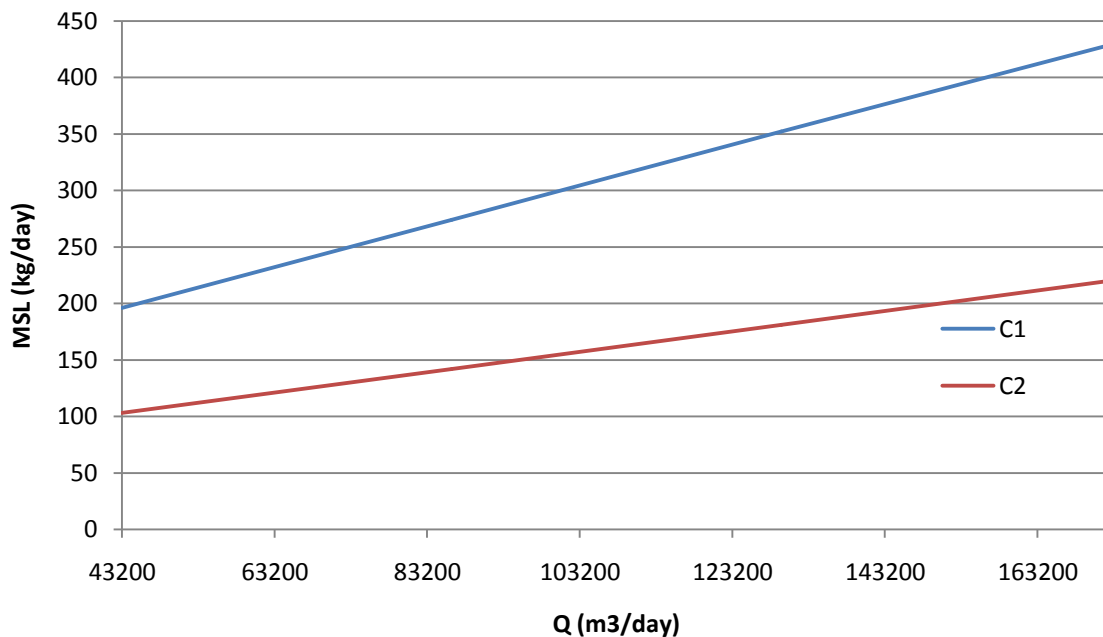

Figure 43: MSL related to variability in discharge

Q	43200	86400	129600	172800
N	284.21	385.71	437.84	469.57
P	23.68	32.14	36.49	39.13

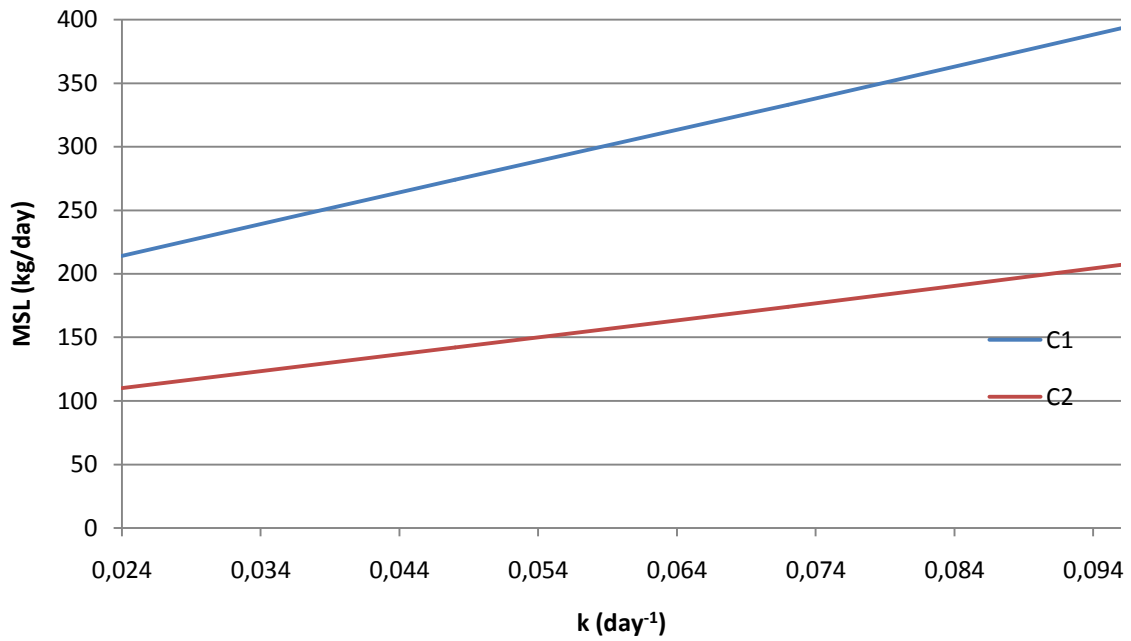

Figure 44: MSL related to variability in removal rates

k	0.024	0.048	0.072	0.096
N	469.57	385.71	327.27	284.21
P	39.13	32.14	27.27	23.68

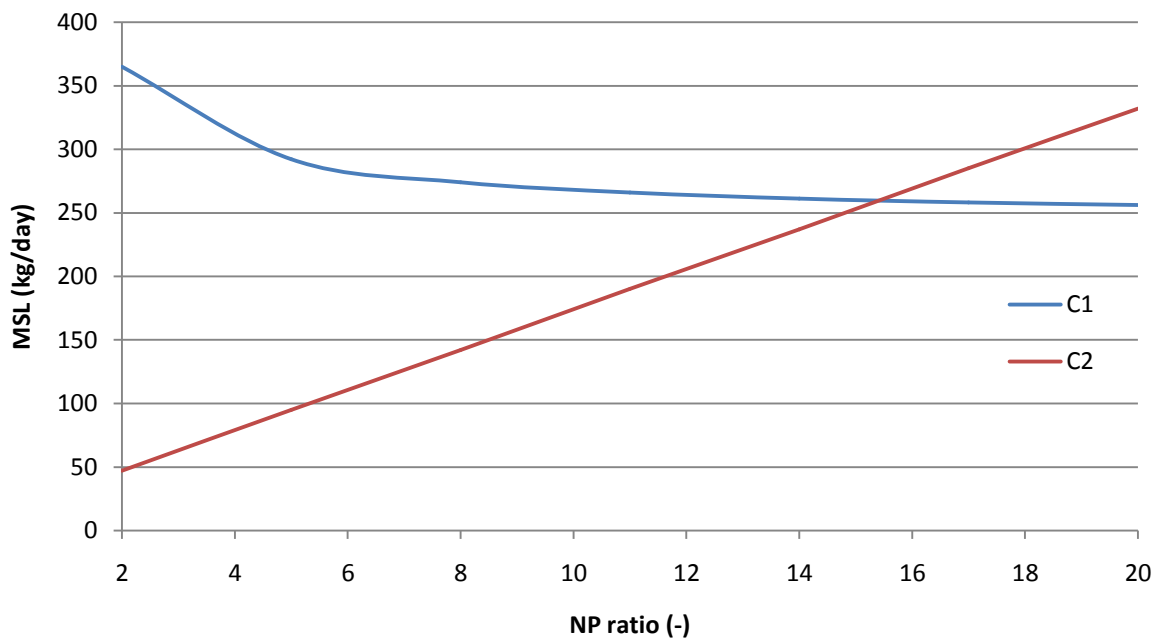

Figure 45: MSL related to variability in the nitrogen and phosphorus ratio of the load

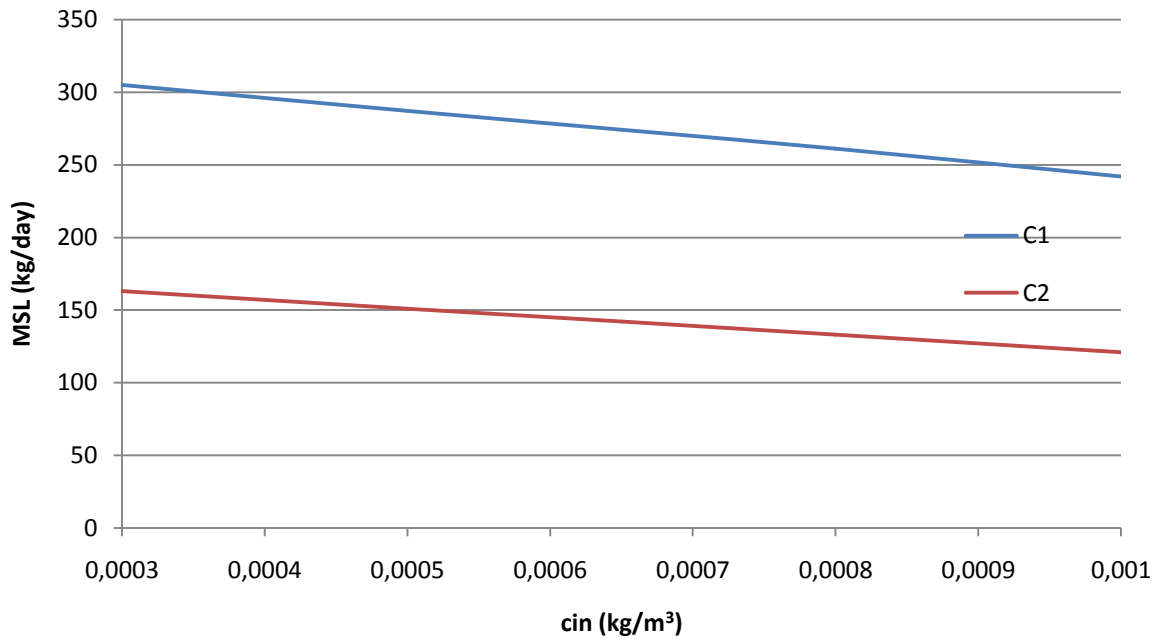

Figure 46: MSL related to variability of the background concentration of the inflow channel

cin	0.0003	0.0005	0.00065	0.0008	0.0010
N	178.02	296.7	385.71	474.73	593.41
P	14.84	24.73	32.14	39.56	49.45

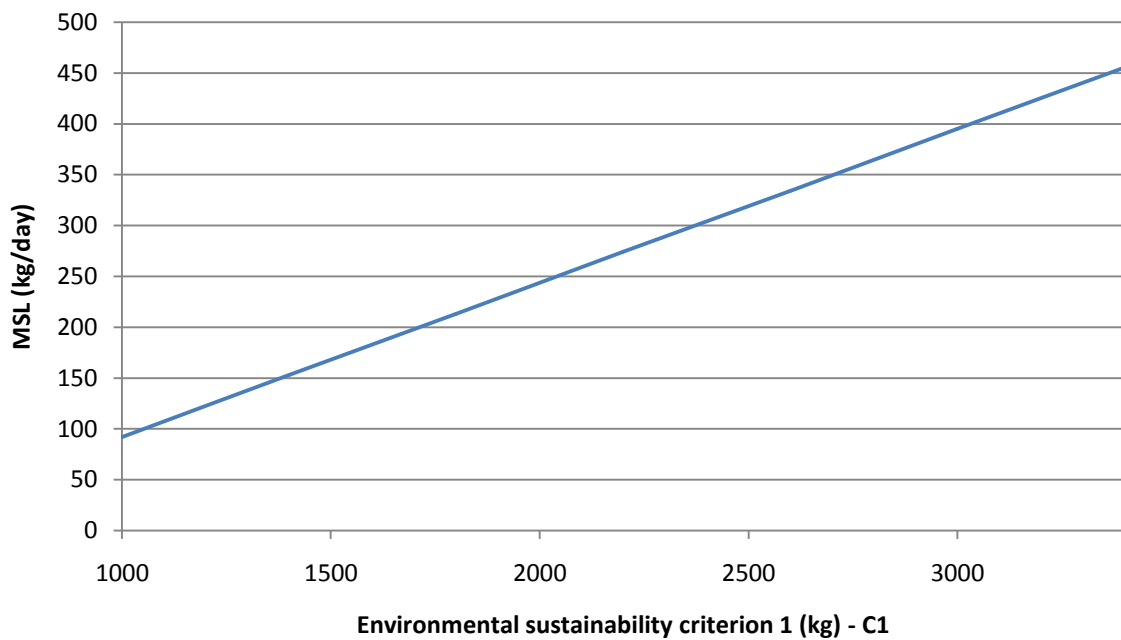

Figure 47: MSL related to variability of C1

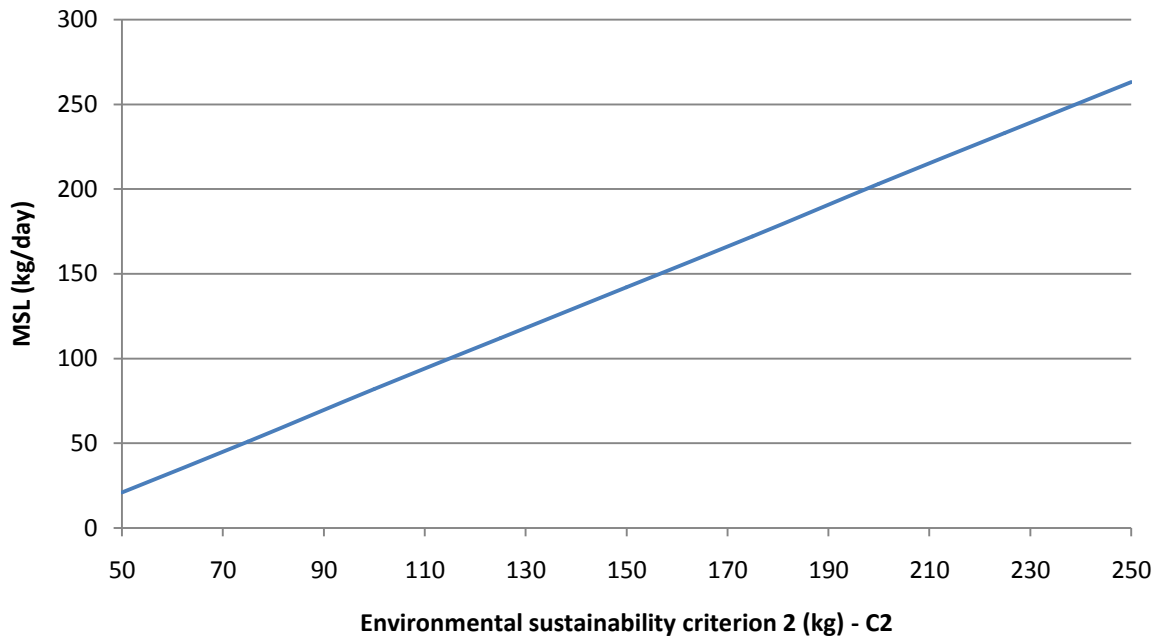

Figure 48: MSL related to variability of C2

The graphs (Figure 43-Figure 48) shows that the variability in the discharge of the inlet channel and outlet channel is positively linear related to MSL-1 and MSL-2. Also the variability in the decomposition rate of the pollution is positively linearly related to MSL-1 and MSL-2. The NP ratio of the load of pollution is positive linearly related to MSL-2. For MSL-1 the variability of the NP ratio shows somewhat weird results. If the NP ratio becomes very high, then per kg of phosphorus there is much more kg nitrogen deposited, wherefore the MSL-1 will stabilize. For values of NP above 6 the NP is negative linearly related to MSL-1. At the value of 5 a bending point is visible and for lower values of NP the MSL-1 is increased much faster than before the bending point. Variability in the background concentration of the inflow channel is negative linear related to MSL-1 and MSL-2. Variability in both sustainability criteria show the presumed results.

### 3.3.7 Sensitivity analysis of MSL

To get more insight in which parameters are changing the MSL faster or slower, a sensitivity analysis is done. With the help of a scaling procedure, whereby all parameters are divided by its default value graphs can be presented with all the parameters in one plot.

#### Sensitivity of MSL-1 on paramter variability

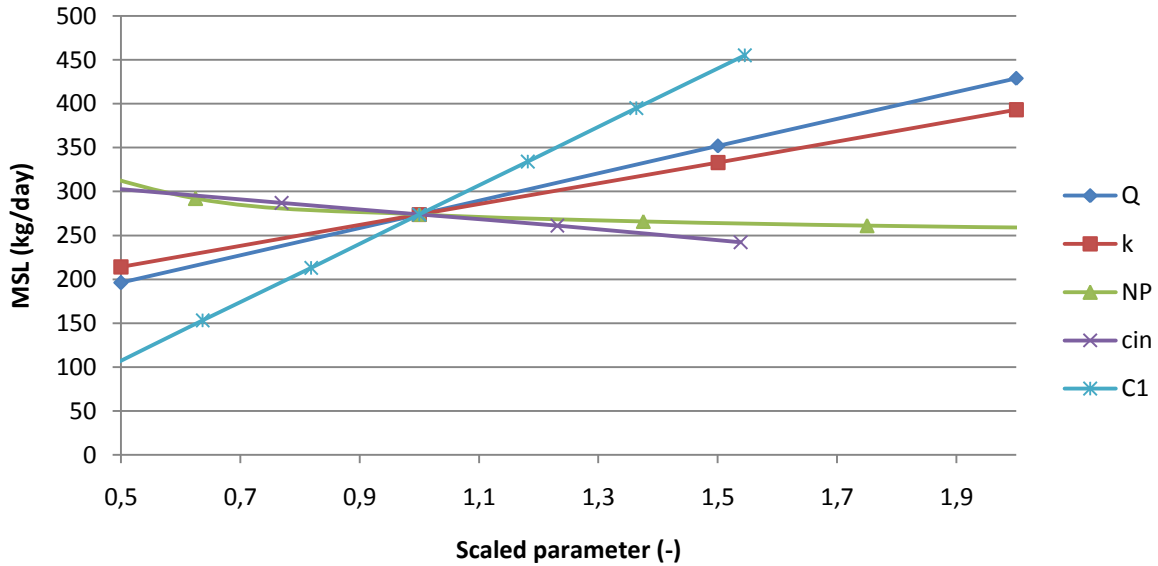

Figure 49: Sensitivity of MSL on parameter variability for C1

#### Sensitivity of MSL-2 on parameter variability

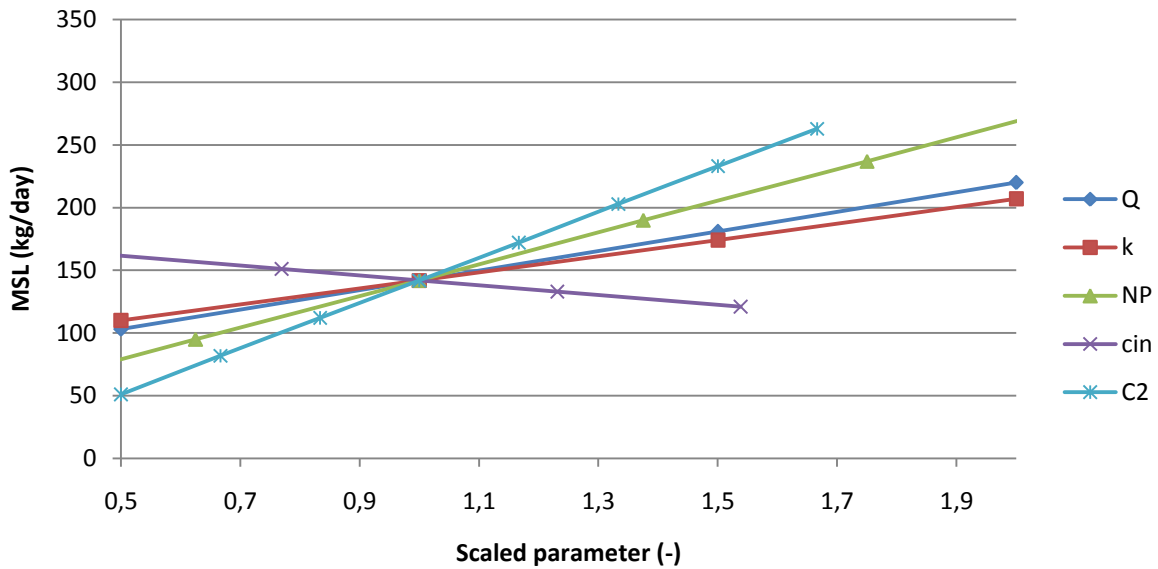

Figure 50: Sensitivity of MSL on parameter variability for C2

The MSL-1 and MSL-2 are most sensitive for changes in the environmental sustainability criteria 1 and 2 respectively, followed by the discharge for MSL-1 and NP ratio for MSL-2.

### 3.3.8 Tipping line of the environmental sustainability criteria

The tipping line where the decisive criterion changes from C1 to C2 or from C2 to C1 is investigated here. The vertical axis presents environmental sustainability criterion 1, which implies the maximum load of nitrogen in the lake. The horizontal axis presents environmental criterion 2, which implies the maximum load of phosphorus in the lake. Exact on the tipping line MSL-1 and MSL-2 are equal.

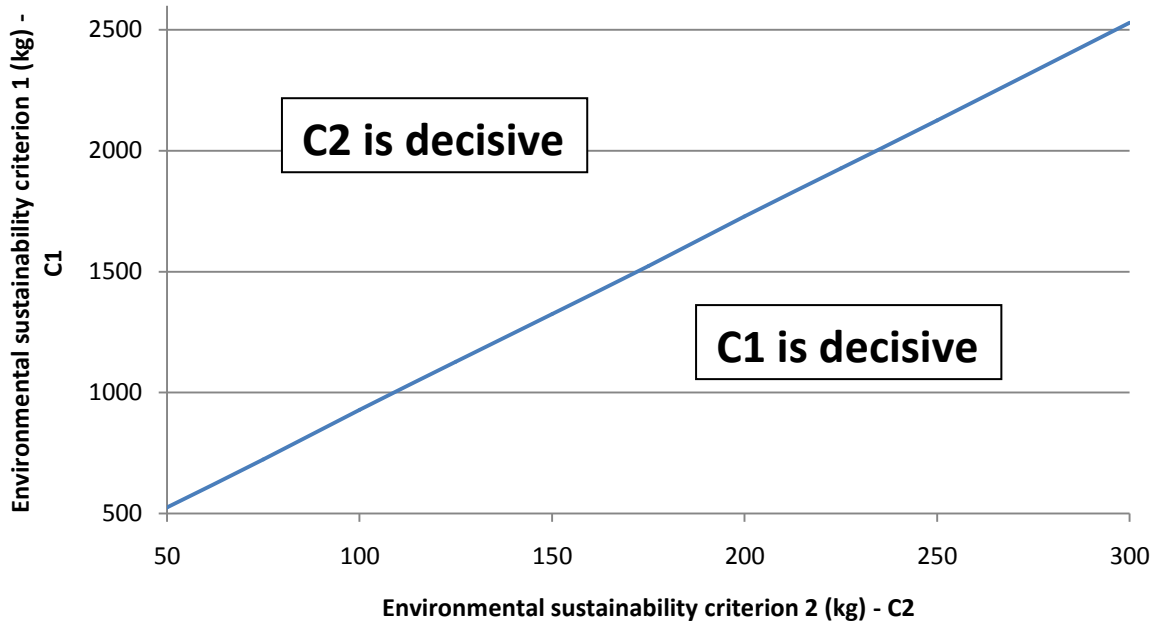

Figure 51: Relation between C1 and C2 for pollution in a lake

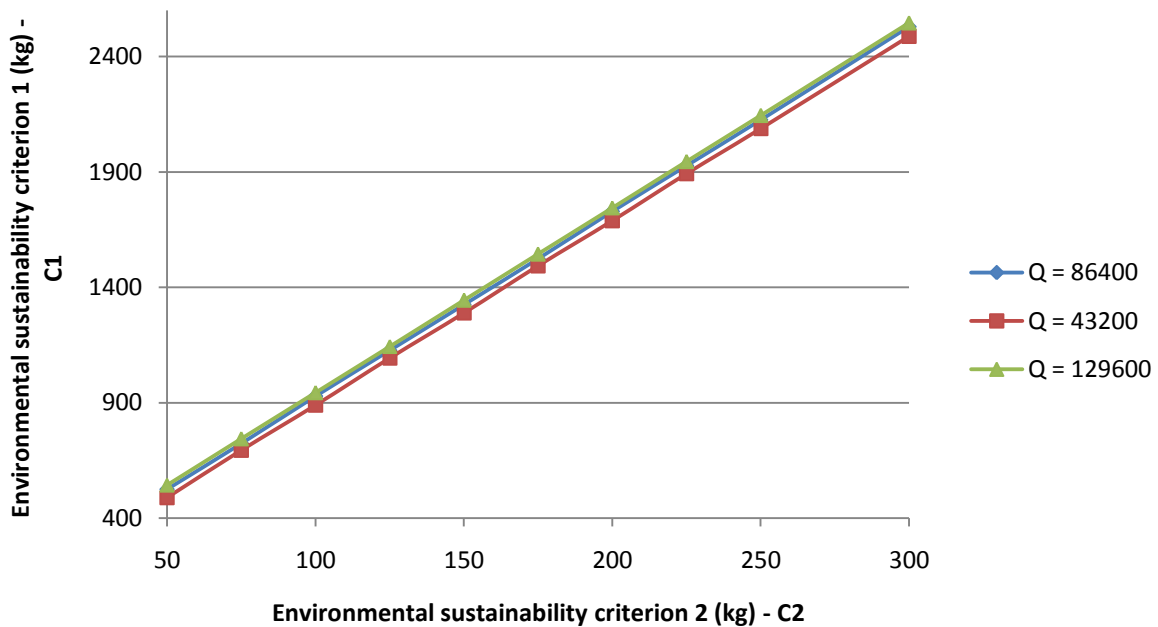

Figure 52: Relation between C1 and C2 for varying discharge values

If the Discharge of the inlet and outlet channel increases, and the concentration of the background pollution stays the same, then more mass of pollutants are brought into the system with a NP ratio of

12. However, the ratio between nitrogen and phosphorus criteria is 2200/150 is 14.67. Therefore the change that C1 becomes decisive will increase negligible for increasing discharges, due to the small difference in ratios.

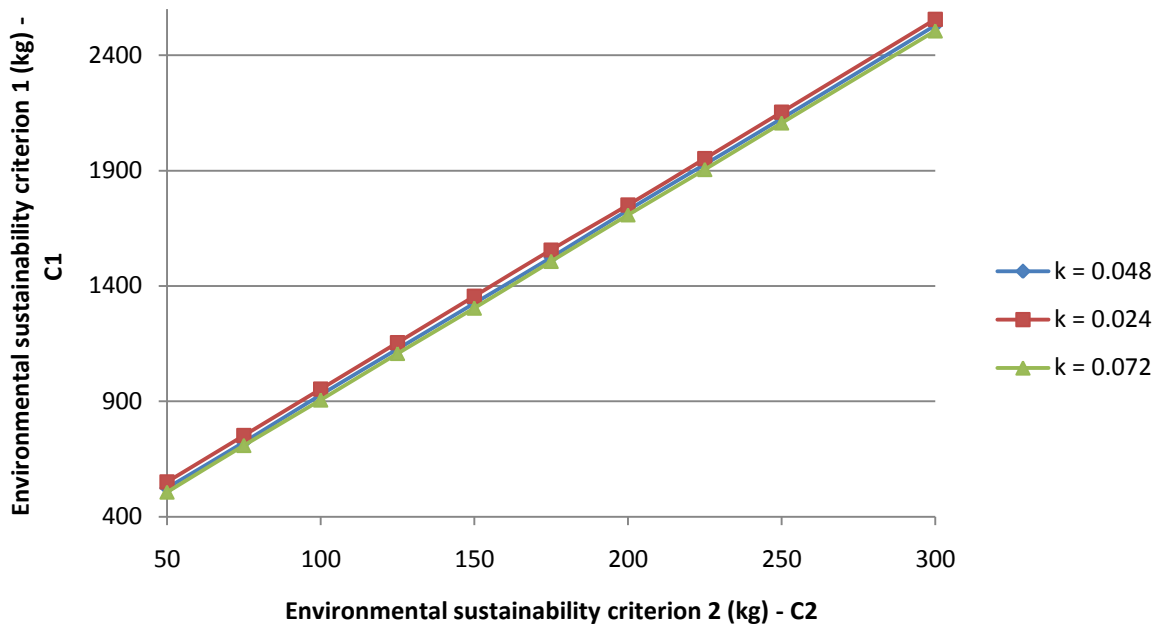

Figure 53: Relation between C1 and C2 for varying removal rates

If the removal rate increases then pollutants will be degraded faster, which means that less pollutants are in the lake. However, also here the ratio between nitrogen and phosphorus is hardly affected, and therefore the tipping line only shows minor changes for varying decomposition rates. The change that C1 becomes decisive will decrease negligible for increasing removal rates.

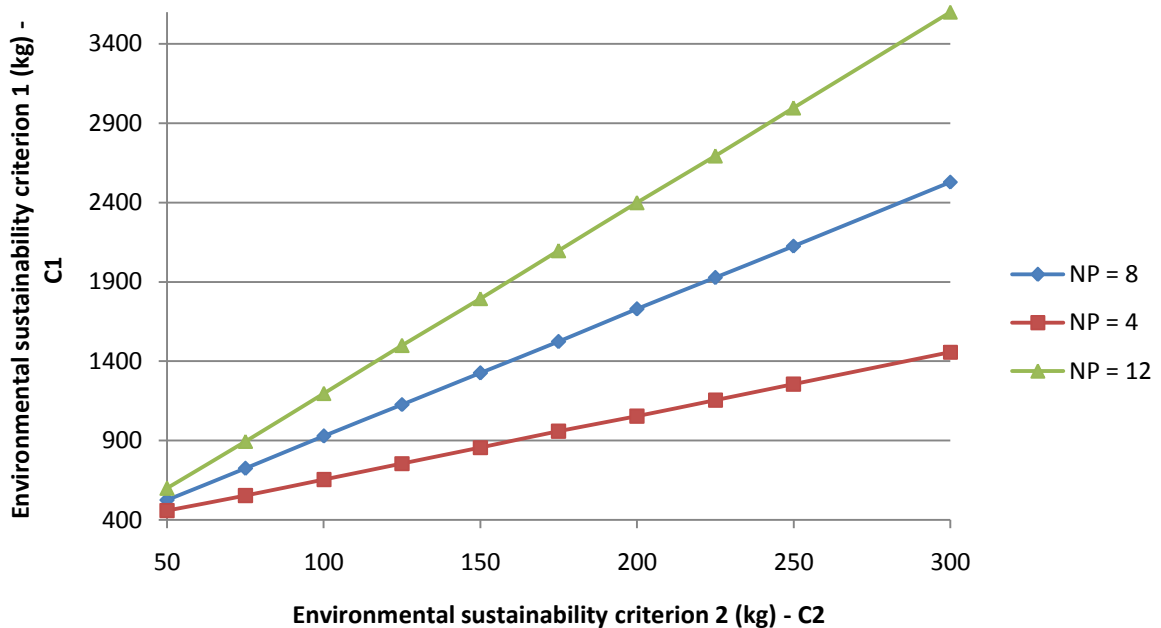

Figure 54: Relation between C1 and C2 for varying NP ratio values



Increasing NP ratio of the pollution load will result in less phosphorus that is deposited in the lake for the same load rate. The change that C1 becomes the decisive criterion will be increased considerably for large NP ratio values.

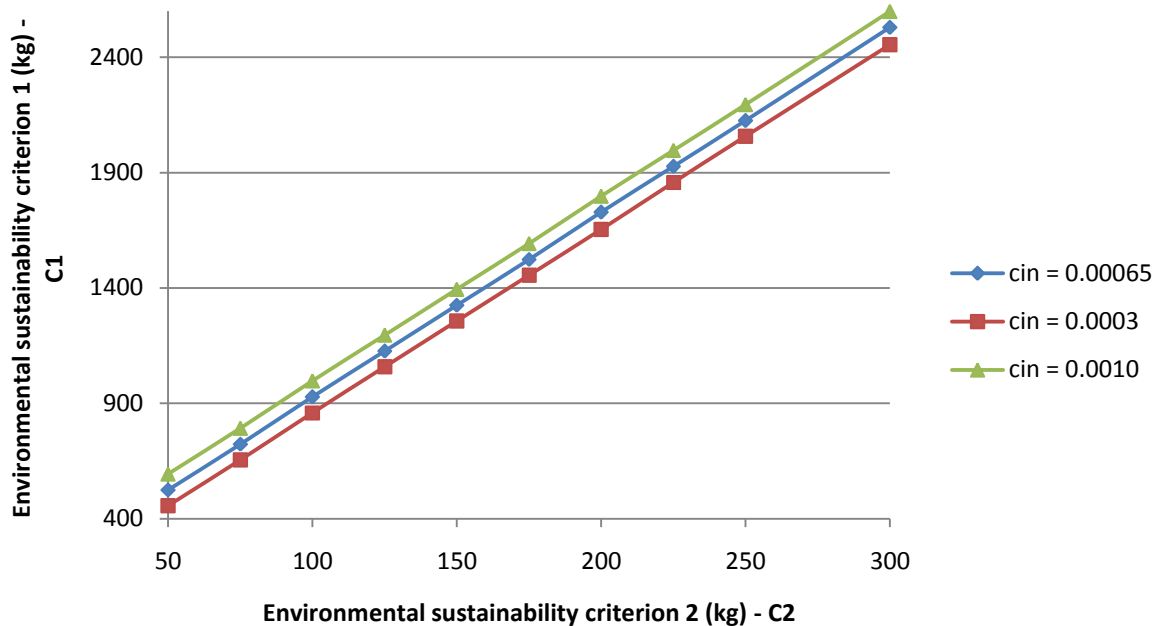

Figure 55: Relation between C1 and C2 for varying background concentrations

Increasing the background concentration of the inflow channel will result in more pollutants that enter the lake. Due to the fact that the NP ratio of the load of the pollution source is smaller than the NP ratio of the inflow channel a change in the NP ratio of the lake takes place. Therefore the chance that C1 becomes decisive is increased very slightly for increasing values of the background concentration of the inflow channel.

Only for varying values of the NP ratio of the pollutant load the gradient of the tipping lines changes. The two rules about the gradient of the tipping line that were set in the groundwater model does also apply on this model. However both sustainability criteria should be turned.

Also the pollution in lake knows three starting condition.

#### Environmental sustainability criterion 1 is decisive for the determination of the MSL.

- Increasing the discharge of the in and outlet channel will increase the MSL and when C2 becomes decisive, it will increase with a lower gradient. Decreasing the discharge will decrease the MSL.
- Increasing the decomposition rate will increase the MSL and when C2 becomes decisive, it will increase with a lower gradient. Decreasing the decomposition rate will decrease the MSL.
- Increasing the NP ratio of the pollutant load will decrease the MSL. Decreasing the NP ratio of the pollutant load will increase the MSL and when C2 becomes decisive, it will decrease again.

- Increasing the background concentration of the inlet channel will decrease the MSL. Decreasing the background concentration of the inlet channel will increase the MSL and when C2 becomes decisive it will increase further with a slightly lower gradient.
- Increasing environmental sustainability criterion 1 will increase the MSL until C2 becomes decisive. Decreasing the environmental sustainability criterion 1 will decrease the MSL.

**Environmental sustainability criterion 2 is decisive for the determination of the MSL.**

- Increasing the discharge of the in and outlet channel will increase the MSL. Decreasing the discharge of in and outlet channel will decrease the MSL and when C1 becomes decisive, it will decrease faster.
- Increasing the decomposition rate will increase the MSL. Decreasing the decomposition rate will decrease the MSL and when C1 becomes decisive, it will decrease faster.
- Increasing the NP ratio of the pollutant load will increase the MSL and when C2 becomes decisive, it will decrease again. Decreasing the NP ratio will decrease the MSL.
- Increasing the background concentration of the inlet channel will decrease the MSL and when C2 becomes decisive it will decrease with a slightly higher gradient. Decreasing the background concentration will increase the MSL.
- Increasing environmental sustainability criterion 2 will increase the MSL until C2 becomes decisive. Decreasing the environmental sustainability criterion will decrease the MSL.

**The maximum sustainable yield is determined by both criteria.**

- Increasing the discharge of the in and outlet channel will increase the MSL with the rate that is determined by C2. Decreasing the discharge will decrease the MSL with the rate that is determined by C1.
- Increasing the decomposition rate will increase the MSL with the rate that is determined by C2. Decreasing the decomposition rate will decrease the MSL with the rate that is determined by C1.
- Increasing the NP ratio of the pollutant load will decrease the MSL with the rate that is determined by C1. Decreasing the NP ratio of the pollutant will decrease the MSL with the rate that is determined by C2.
- Increasing the background concentration of the inlet channel will decrease the MSL with the rate that is determined by C1. Decreasing the background concentration will increase the MSL with the rate that is determined by C2.
- Increasing the environmental sustainability criterion 1 will not affect the MSL. Decreasing the environmental sustainability criterion 1 will decrease the MSL.
- Increasing the environmental sustainability criterion 2 will not affect the MSL. Decreasing the environmental sustainability criterion 2 will decrease the MSL.

### 3.3.9 Feedback to reality

The case studies in literature are often using the total maximum daily load (TMDL). This is total maximum daily load also includes the natural inflows. Effler et al. (2002) investigated this and defined a TDML of phosphorus for the Onondaga Lake. They defined a TMDL of 63.5 kg/day. In our model the TDML according to the decisive sustainability criterion is 15.24 kg/day including background concentration loading, which is much lower than used in the literature study. However the total volume of water in the Onondaga lake is 131 MCM, which is 131 times more than in our

model. Walker (2000) also investigated the TMDL for lake Okeechobee. He estimated a TMDL of 380 kg phosphorus per day. Although also for lake Okeechobee the dimensions are much larger, namely 5200 MCM. In comparison to our model, probably the dimensions of the lake were underestimated. Though between both case studies also a lot of difference in TMDL is noticeable with regard to the dimensions of the lake, wherefore TMDL is varying a lot for different lakes.

### 4. Comparison of the three models

Now that the three models are investigated separately, it is time to investigate if the three models have commonalities and if something can be said about the behavior of environmental systems in general. As a reminder and to get an overview, in Figure 56 the system diagrams of the environmental systems and the according parameters and equations are shown.

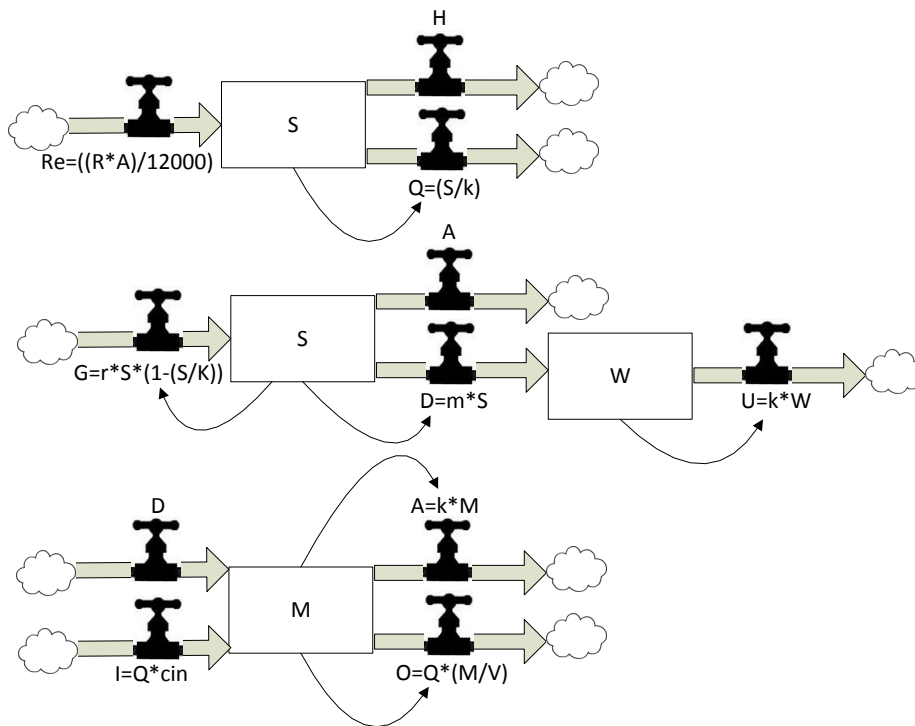

Figure 56: Overview of the investigated environmental systems

Although the models of the environmental systems look like each other, there are some characteristics that can make the difference about how the system reacts to a disturbance. In the following table the qualitative characteristics of the systems are shown. This will give a more clear indication how the environmental systems differ from each other. However, for simplicity, the second stock in the biomass in a forest model is neglected even as the decomposition rate of dead wood, so that the system is a single stock system.

No.	Characteristics	Groundwater model	Biomass model	Pollution model
1	Number of natural inflow(s)	1	1	1
2	Feedback loop on natural inflow	No	Yes	No
3	Behavior of natural inflow	Constant	Parabolic	Constant
4	Number of natural outflow(s)	1	1	2
5	Feedback loop on natural outflow	Yes	Yes	Yes
6	Behavior of natural outflow	Linear positive	Linear positive	Both linear positive
7	Form of disturbance	Yield	Yield	Load
8	Type of sustainability criterion 1	Absolute reduction	Relative	Fixed
9	Location of the criterion	Stock	Stock	Stock

10	Type of sustainability criterion <sup>2</sup>	Relative	Absolute reduction	Fixed
11	Location of criterion	Outflow	Stock	Stock

Table 4: Characteristics of the three environmental systems

#### 4.1 Inflow characteristics

The number of natural inflows are for all the investigated models the same. The question arises if the environmental systems would react differently if there were more natural inflows in the models. The answer to this question depends on the behavior of the second new introduced natural inflow. If the second inflow has the same behavior as the other one, then the second natural inflow may be represented by an increase in parameter  $R$  for groundwater,  $r$  for biomass and  $c_{in}$  for the pollution model. Thus, the number of inflows have no influence on the behavior of the system, except if the behavior of the second new introduced inflow is different than the natural inflow. Examples of forms of inflow behavior are presented in Figure 57.

The behavior of the inflow has strong linkages with the presence of a feedback loop. In general, if there is no feedback loop present for the inflow entity, then the inflow will behave like a constant, which is the case for the groundwater and pollution model. However, it should be noted that this is only the case when the stock or natural capital is the only state variable in the system. An inflow may depend on another process that is not constant in time. A good example is the biomass in a forest model where the dead biomass stock inflow depends on the living biomass stock. In this system there are two state variables, but for simplicity the dead biomass stock is neglected. Nonetheless, if the inflow has a feedback loop then the behavior of the inflow is not constant for varying stocks. Therefore, the presence of a feedback loop on the inflow entity indicates that the behavior of the inflow can be anything except constant. This may be linear, exponential or even parabolic as in the biomass model or another relationship. The next figure shows the 3 examples of different inflow behaviors for varying stock values.

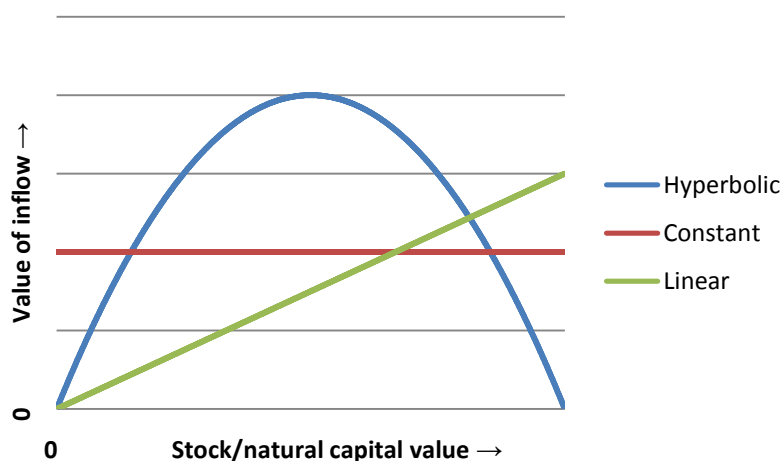

Figure 57: Inflow behavior of environmental systems

Constant inflows will not react on any type of disturbance or change to the system. The linear inflow that is shown in Figure 57 means that higher stock values will cause higher inflows. A disturbance to a system with a linear inflow will be affected by an ongoing process. A yield disturbance to a system

will cause a lower level of the stock, which will lead to a lower amount of new resources that enters the system, this again lowers the stock of the system again and so on. A load disturbance will increase the level of the stock which will increase inflow of the system, this will again increase the stock equilibrium and so on. Parabolic inflow behavior is more complex. How a system reacts on a disturbance with parabolic inflow behavior depends on the equilibrium level of the stock. If this equilibrium level of the stock corresponds with an inflow that is located on the right hand side of the parabola (from the top), then a yield disturbance will result in higher inflows, which means that the stock is declining slower. A load disturbance will lead to lower inflows, which again result in a slower increase of the stock. For the left hand side the opposite is valid. yield disturbances will lead to lower stocks that again will result in lower inflows. load disturbances will lead to higher stocks and increased inflows. Therefore, parabolic inflow behavior does have a tipping point from where the behavior of the system changes. This tipping point is located exact on the top of the parabola.

However, the top of the parabola might take another position if the interaction with the outflow entities is considered. Therefore the outflow characteristics of a system are as important as the inflow characteristics.

Inflows that will rise with increased stocks are affected by a reinforcing feedback, that will lead to exponential growth or runaway collapses (left side of parabola). Inflows that will decline with increased stocks are affected by an balancing feedback that show equilibrating and goal seeking behavior (right side of parabola). The tipping point will be discussed later in this chapter.

## 4.2 Outflow characteristics

The number of outflows is different for the pollution in a lake model. However, these outflow entities can be combined without changing anything to the system itself.

$$A + O = (k * M) + \left( Q * \frac{M}{V} \right)$$

$$A + O = M * \left( \frac{Q}{V} + k \right)$$

The number of outflows do not influence the behavior of the system, except if a new introduced outflow behaves different than the natural outflow process. The next figure shows three different outflow behaviors.

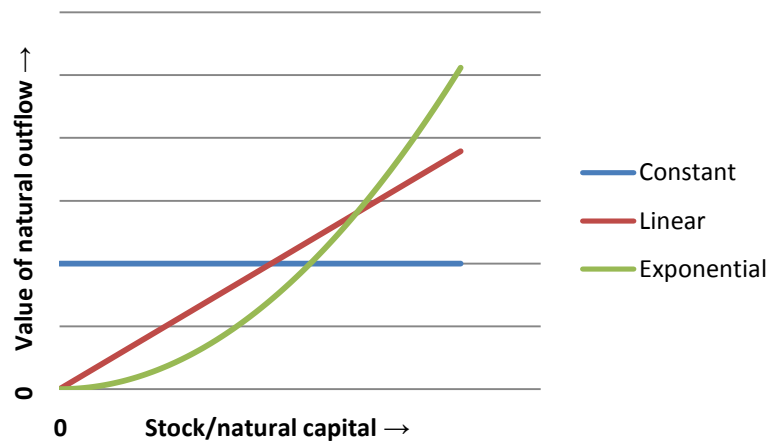

Figure 58: Outflow behavior of environmental systems

All the natural outflows of the modeled environmental systems behave linear. Yield disturbances will lower the stock, but the natural outflow component is also lowered, therefore the stock is declining slower. Load disturbances will increase the stock which will result in increased outflows, therefore the stock will increase slower.

Outflows that will rise with increased stocks are affected by a balancing feedback that is equilibrating and goal seeking. Outflows that will decline with increased stocks are affected by a reinforcing feedback that will lead to exponential growth or runaway collapses.

To determine how the system as a whole responds to disturbances, the interaction between inflow and outflow entities should be considered.

### 4.3 Characteristics of the systems

In the previous paragraph the outflow entities of the pollution model was combined to one inflow entity. Without disturbances, the pollution model is equal to the groundwater model. The only difference is the form of disturbance. The pollution model has a load disturbance while the groundwater model has a yield disturbance. The form of disturbance is one of the distinguished characteristics of environmental systems behavior.

Furthermore the behavior of the inflow and outflow entities are the other distinguished characteristics of the environmental systems behavior. Together they will form the behavior of the system itself. The next figure shows the behavior of the three environmental systems, which is the inflow minus the outflow behavior.

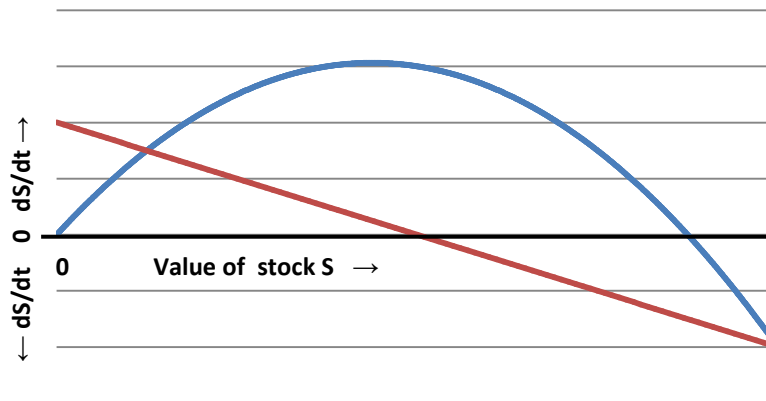

Figure 59: Behavior of environmental systems

The blue line is the behavior of the biomass model and the red line is the behavior of groundwater model and the pollution model. Disturbances to the system are assumed to be constant in time and therefore a disturbance will shift the behavior line downwards in case of a yield disturbance and upwards in case of a load disturbance. The intersection with the horizontal axes presents the equilibrium value of the stock (inflow is equal to outflow). Due to the absence of a reinforcing feedback loop in the groundwater model and the pollution model, both systems behave fully stable. The biomass in a forest model however is partly stable. The tipping point from where the environmental system changes from stable to unstable is the top of the parabola. If the yield disturbance is larger than this tipping point a runaway collapse of the environmental system occurs and the stock will be zero. Fully unstable systems are also possible but are very fragile. A very small disturbance will already lead to an exponential growth or a runaway collapse. These are, however, not treated in this study.

The gradient of the behavior indicates how well a system can adapt to disturbances. Since a disturbance will lead to a shift of this behavior line downwards or upwards, the equilibrium value of the steeper lines will decline/increase much slower. Shifts of lines with a lower gradient will lead to a much faster decline/increase of the equilibrium stock value.

#### 4.4 Sustainability characteristics

In the introduction already a statement was made about environmental sustainability rules that are supported by certain authors. These environmental sustainability rules include that the waste emissions or harvest rates should be within the assimilative or regeneration capacity (Goodland, 1995). However, as also can be concluded from the previous chapter the MSY or MSL always lies far beneath the assimilative or regeneration capacity of the environmental system, so that these rules are actually defined too wide. The maximum sustainable yield would only be equal to the regeneration capacity if the system has one inflow and one outflow which is the yield disturbance. For waste systems this exact the opposite namely the system has one outflow and one inflow which is the load disturbance. The natural capital will then stay constant, nonetheless this is almost never the case.



In the three models that are investigated, the regeneration capacity or assimilative capacity can be increased or decreased by changing the parameters. The parameters that are assumed to influence the regeneration and assimilative capacity are showed in the next table 5.

Model	Groundwater model	Biomass model	Pollution model
Parameter	Recharge R	Grow rate r	Removal rate k

**Table 5: Parameters that influence the regeneration/assimilative capacity**

Changes in the above mentioned parameter will result in a higher or lower stock value wherefore a presumption is present. The presumption includes that increasing the systems regeneration capacity or assimilative capacity would increase the maximum sustainable yield or maximum sustainable load. Decreasing the systems regeneration capacity or assimilative capacity would decrease the maximum sustainable yield or maximum sustainable load. The presumption is supported by other authors that relate the MSY or MSL to regeneration/assimilative capacity described in the introduction .

The presumption is contradicted by results of the previous chapter. In the groundwater model an increase of recharge was not affecting the maximum sustainable yield according to sustainability criterion 1. This probably has to do with how the environmental sustainability criteria are defined. There are three different ways environmental sustainability criteria are defined in this study. Firstly, a criterion may be defined as a minimum/maximum value of the equilibrium value in percentages, which is a relative criterion. Secondly, a criterion may be defined as a maximum reduction/enlargement from the equilibrium value in the units of the system, which is an absolute reduction criterion. Thirdly, a criterion may be defined as a certain threshold that may not be exceeded, which is a fixed absolute criterion.

The default sustainability criterion will be transformed to three sustainability criteria that each have the same maximum allowable reduction in the equilibrium situation without a disturbance. All the other parameters have their default value. After that the regeneration or assimilation capacity is increased or decreased.

Environmental Sustainability criteria		Groundwater model	Biomass model	Pollution model
<b>Default sustainability criterion 1 - C1</b>		max red. 1 meter	80% of biomass	2200 kg N
<b>C1-1</b>	Relative criterion	73%	80%	570%
<b>C1-2</b>	Absolute reduction criterion	1 meter	175 m3	1814 kg N
<b>C1-3</b>	Fixed absolute criterion	0.71 m + river level	700 m3	2200 kg N
<b>Default sustainability criterion 2 - C2</b>		80% of base flow	max red. 40 m3	150 kg P
<b>C2-1</b>	Relative criterion	80%	73%	467%
<b>C2-2</b>	Absolute reduction criterion	56250 m3/month	40 m3	118 kg N
<b>C2-3</b>	Fixed absolute criterion	225000 m3/month	105 m3	150 kg P

**Table 6: Types of environmental sustainability criteria**

Investigating how the maximum sustainable yield changes when the regeneration or assimilation capacity of the model for different types of criteria is changed would be a logical next step. The type of criterion will be indicated with a number behind the C1 or C2. 1 indicates a relative criterion, 2 indicates absolute reduction/enlargement criterion and 3 a fixed criterion. The grey lines are the default criteria as shown in the previous table. An overview is presented in Table 6.

Groundwater model:

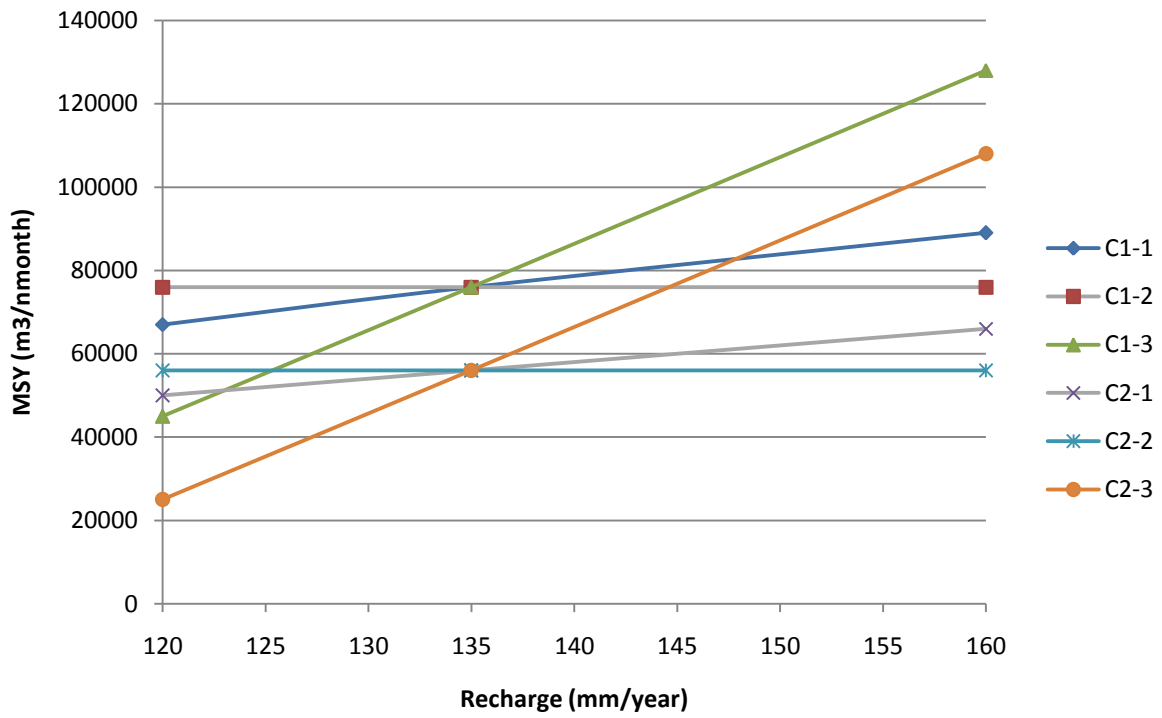

Figure 60: Influence of different types of criteria on the MSY for changing groundwater regeneration capacities

Biomass in a forest model:

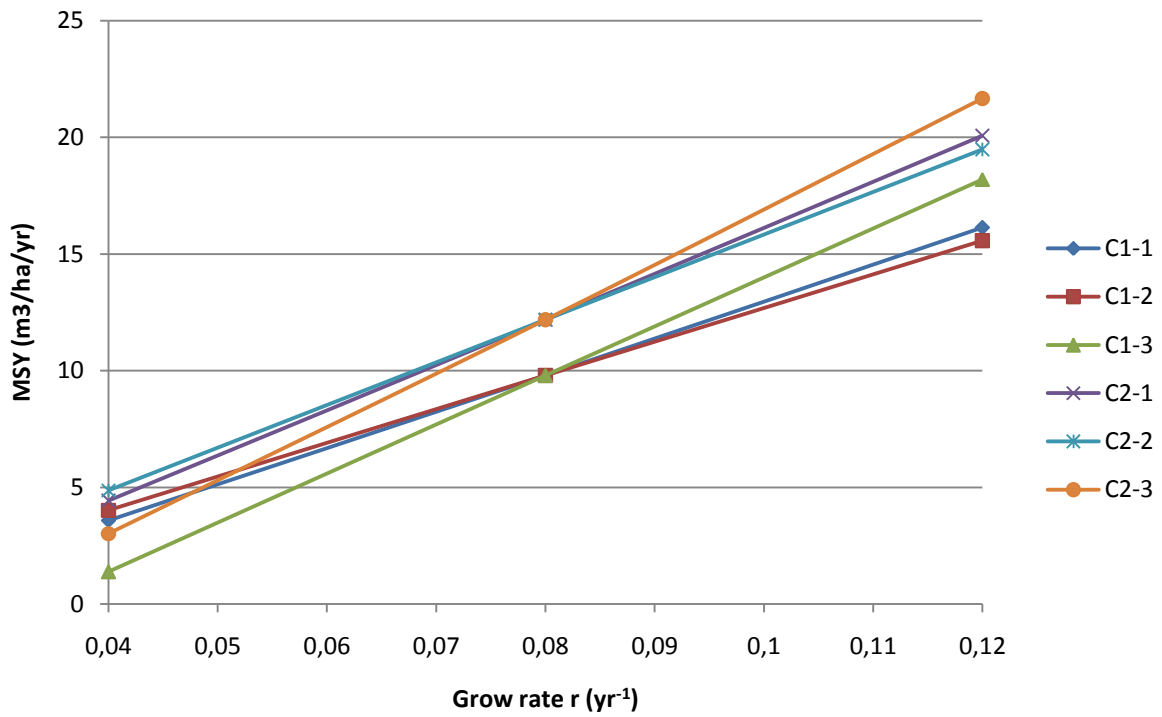
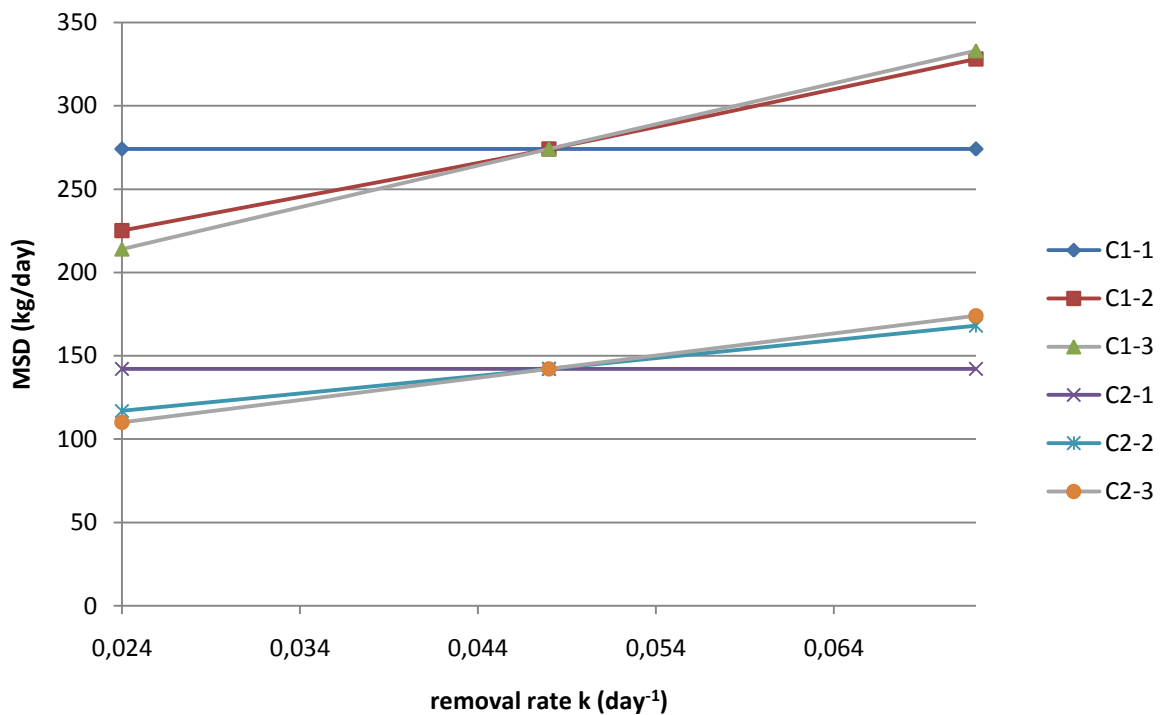

Figure 61: Influence of different types of criteria on the MSY for changing biomass regeneration capacities

**Pollution in a lake model:**

**Figure 62: Influence of different types of criteria on the MSL for changing pollutant removal rates**

All the three environmental systems are reacting different on different types of environmental sustainability criteria for variability in regeneration/assimilative capacity. This can best be explained by the distinguished characteristics of the systems that are described previously. The focus of the explanation is about the sustainability of the stock, because most environmental sustainability criteria are defined at the stock. Due to the different responses on types of criteria the type of criteria can also be indicated as a distinguished feature.

The groundwater model is a linear system which has constant inflow behavior and positive linear outflow behavior. This will result in a negative linear behavior line (inflow minus outflow). Yield disturbances always take something out of the system. Consequently, to increase its regeneration capacity the inflow should be increased. Increasing the inflow will consist of a shift of this constant line upwards. This will again lead to an upwards shift of the behavior line which will increase the equilibrium value of the stock. However a shift of this behavior line will not influence the gradient of the line. Increasing the system regeneration capacity will not influence the adaptability of the system, wherefore yield disturbances will decline the stock at the same rate as before. The absolute reduction criterion will therefore not affect the MSY for varying regeneration capacities. A relative criterion and fixed absolute criterion will affect the MSY for varying regeneration capacities, because varying regeneration capacities has influence on the equilibrium level of the stock. The maximum tolerable reduction will therefore also change.

The linear pollution in a lake model is behaving differently than the groundwater model despite the same inflow and outflow behavior. This mainly has to do with how the regeneration/assimilative capacity is varied. In the pollution model the removal rate  $k$  is varied as a representation of the variability in the assimilative capacity. Varying the removal rate  $k$  means that the gradient of the

outflow behavior changes. This will lead to a changed gradient for the systems behavior line, which again means that the systems adaptability to disturbances is changed. Variability of the assimilative capacity will affect the MSL that is calculated with an absolute enlargement criterion, because the systems adaptability is changed. Variability of the assimilative capacity will also affect the MSL that is calculated with a fixed absolute criterion, because the equilibrium level of the stock is changed. However, variability of the assimilative capacity will not affect the MSL that is calculated with a relative criterion. Higher removal rates will decrease the equilibrium stock and a relative criterion will give a lower maximum tolerable increase of the pollutant. However, the gradient of the behavior line is larger, wherefore the systems adaptability to disturbances is improved. These two processes cancel each other out, which means that the MSL will not change. The percentage difference between the equilibrium stocks and the criteria values will stay the same for variable assimilative capacities as well. Although, it should be noted that changing the removal rate will not change the point where the outflow intersects the y axis. The intersection of the behavior line with the y axis will therefore also not change. So the change in gradient should occur from the intersection with the y axis. Figure 63 is showing this in a more clear way.

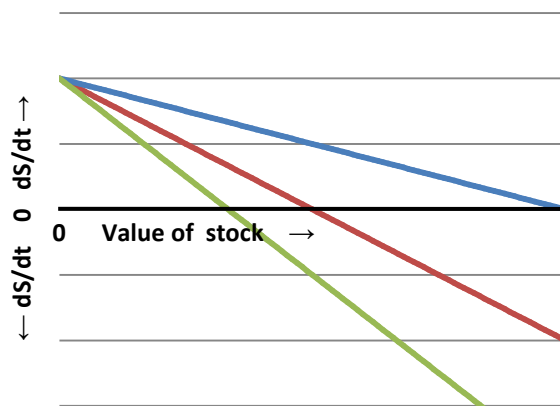

Figure 63: Change of gradient

The gradients of the behavior lines in Figure 63 are all different, but have the same intersection with the y axis, wherefore the MSL is for all the behavior lines the same in case of relative sustainability criterion. This is a precondition for the exception to be valid.

The biomass in a forest model is a non linear model and is consequently behaving different. The inflow has a parabolic behavior and the outflow a positive linear behavior. Variability in the regeneration capacity of the forest is represented as variability in the grow rate of the forest. Increasing the grow rate in the logistic growth formula will result in an increase in the top of the inflow parabola. Increasing the top of the parabola but keeping the sides of the parabola at the same position (zero and the carrying capacity) will lead to an upwards shift and increased gradients of the parabola. Variability in regeneration capacity that is represented by a variability in grow rate will therefore affect the MSY always regardless the type of criteria.

Basically, the MSY/MSL is not affected by variability in regeneration/assimilative capacity if the system is stable, linear, has a stock related absolute reduction criterion, and the variability in regeneration/assimilative capacity is represented as a shift of the systems behavior line, whereby the gradient is not changed. This is also visible in Figure 60.

Furthermore the MSY/MSL is also not affected by variability in regeneration/assimilative capacity if the system is stable, linear, has a stock related relative criterion, and the variability in the regeneration/assimilative capacity is represented as a change in the gradient of the systems behavior line, whereby no shift is taken place. The change in gradient should occur from the intersection with the y axis as is shown in Figure 63. This is also visible in Figure 62.

The above described phenomena may occur in resource system as well as a waste system, as long as the other described systems characteristics are the same.

The MSY/MSL of non linear systems will probably always be affected by variability in regeneration/assimilative capacity regardless the type of environmental sustainability criterion. Also the MSY/MSL that is calculated with a fixed absolute criterion will probably always be affected by variability in regeneration/assimilative capacity.

For flow related environmental sustainability criteria the MSY/MSL may also not be affected by variability in regeneration/assimilative capacity as is also visible in Figure 60. The system should have the same characteristics as described earlier for stock related environmental sustainability criteria. However the flow should be connected to the stock through a feedback loop and the way of implementation of the variability in regeneration/assimilative capacity should not occur at that specific flow.

However, it should be noted that defining a fixed absolute environmental sustainability criterion is not applicable in a general way. Consider a groundwater model where the initial groundwater level is 2 meters below surface and a fixed absolute sustainability criterion has been defined that the groundwater level may not be lower than 4 meters below surface. If this environmental sustainability criterion is applied for a groundwater aquifer in a (semi) arid area, where the initial groundwater level without abstraction already lies 6 meters below surface, then this groundwater aquifer is already unsustainable without human interference.

## 4.5 Major assumptions of the models

The three environmental systems do all have a major assumption, which reduces the complexity of the system. This paragraph gives description of what would happen if the major assumptions were not made and how this could be implemented in a systems diagram.

### Groundwater model: Linearity

The natural discharge of the groundwater model is assumed to be linear. The level of non linearity of the natural discharge is already quantitatively investigated in 3.1.6. However the behavior of the system is not yet treated. If the outflow will behave exponential then the outflow to the river will be non linear. The systems behavior is therefore also non linear. In Figure 64 the systems behavior of a linear outflow and exponential outflow are shown. With exponential outflow behavior a concave behavior line is present.

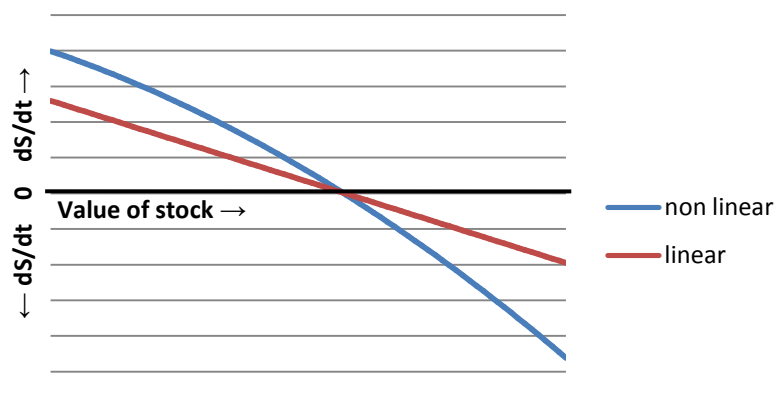

Figure 64: Non linear groundwater model behavior

The gradient of behavior line changes for varying stock values. The gradient of the behavior line is higher for greater stock values and the gradient is lower for smaller stock values. How well the system can adapt to disturbances is also varying. For the non linear behavior line shown in Figure 64 applies that larger yield disturbances will lead to a less adaptive system. However, larger load disturbances will lead to a better adaptive system. If the behavior of the outflow is logarithmic, then the behavior line would be mirrored and convex shaped. This means that yield disturbance will lead to a better adaptive system and load disturbances will lead to less adaptive system. In a linear system the adaptability of the system to disturbances is not affected and stays constant.

### Biomass model: recruitment and aging of biomass

Consider trees as the biomass that is being harvested in the model discussed in this research. The growing process of biomass is actually split up in two other processes namely the recruitment of new trees in the forest which is expressed as number of trees and the growing process of these new trees that might be expressed as cubic meters. Depending on the age of the tree, the tree consist of cubic meters biomass. Since not all the trees in the forest will have the same age, the total amount of biomass will continuously fluctuate. Mortality rates and growing rates will depend on the age of the tree and therefore it is hard to implement these two processes in a system diagram. Also the difference in units between amount of trees and cubic meters of biomass is hard to implement in a

system diagram. To partly implement these two process one can consider to introduce two stocks, whereby one stock is presenting the young trees and the other stock the old trees. A flow will go from the young trees stock to the old trees stock, and the harvesting outflow component will be from the old trees stock, since this stock contain most biomass per tree.

It is hard to say if the maximum sustainable yield is positively or negatively affected by implementing this characteristic, because the complexity has been brought to a next level. However, harvesting is restricted to a tree that contains a minimum amount of biomass or has a minimum age. Therefore the biomass that is suitable for harvesting is lower than in the original model, where all the biomass may be harvested regardless age and biomass volume.

#### **Pollution model: completely mixed system**

The pollution in a lake model is based on a completely mixed system, which neglects the diffusion process taken place in the lake. However, what would happen to the system behavior if the pollution model was based on incompletely mixed system that incorporates the diffusion process? The environmental sustainability criteria were defined as a maximum mass of pollution in the lake and therefore the diffusion process do not influence the behavior of the pollution model even as the maximum sustainable load. However, if the environmental sustainability criteria were defined as a maximum concentration that may not be violated the model would behave differently. Then the incompletely mixed system could be implemented by introducing for example four stocks that all represents a certain area of the lake. In case of point source, the MSL would be negatively affected, because the pollution load is taken place in one of the four stocks, which means that the volume of water will be four times lower at the beginning. as the time goes the pollution would spread across the other three stocks and the concentration in the stock where the load took place will slowly decrease.

What needs to be kept in mind is that the fundamental purpose of system dynamic modeling is to understand the behavior of a system rather than giving a precise representation of reality (Forrester, 2007).

## 5. Discussion

The simple sustainability rules that were defined and supported by Costanza & Daly, (1992); Goodland, (1995) include that the assimilative or regenerative capacity of a system is directly dependent on the MSY or MSL. The variability in the regeneration capacity is presented by changes in the natural inflow entity and the variability in assimilative capacity is presented by changes in the outflow entity in this study. However, from a systems perspective, one could argue that the variability in regeneration or assimilative capacity can also be presented by a change in the outflow entity for yield systems and a change in the inflow entity for waste systems. What needs to be kept in mind is the feasibility of change in the inflow or outflow entity in reality. For example, the groundwater model, where changes in recharge are easily explained by climate change. However, changes in residence time is much harder to explain in terms of a real process that occurs. One could argue that implementing drainage can decrease the residence time, but how might an increase in residence time be explained? Also drainage would probably affect the recharge.

The purpose of the hypothetical environmental system models was to understand the behavior of the systems rather than giving a precise representation of reality. Therefore the MSY and MSL values that are mentioned should not be taken literally. The values of the parameters that determine the MSY/MSL in combination with the sustainability criteria in each environmental system are based on literature studies of similar systems. These parameters often contain a range in which the parameter operate. From this range, assumptions are made for the default value of the parameters. Besides, the dimensions that are chosen in each environmental system are often underestimated. In reality lakes and groundwater aquifers are much larger.

In this study three environmental systems were investigated. The two exceptions that were found are based on two environmental systems. And the statement that the simple sustainability rules is probably always valid for non linear systems is based on one environmental system. These are too few systems to make reliable statements about. The property of non linear systems is that the behavior line will also react non linear on disturbances or parameter changes. The behavior line might be concave or convex, whereby the type of system (waste or yield) will determine if the non linearity will give a favorable or unfavorable effect. Furthermore, to simplify the systems, a lot of assumptions were made in this research, which will also influence the reliability of this study.

The relative criterion and absolute reduction criterion do have a reference point from where they are defined. This reference point is often the initial value of the stock or flow without disturbance. However, the initial value (equilibrium) of the stock without disturbance might change due to a change in one of the parameters as was investigated in chapter 3. A reference based criterion will therefore also change the level of the stock that may not be violated. However, the following question arises is it fair to change the environmental sustainability threshold if one of the parameters is changing? Would environmental agencies monitor the parameters of an environmental system, so that in case of reference based environmental sustainability criterion, the threshold is continuously adapted? Is one type of criteria better than the other and in what way is it better (humans or environment) and why would a certain type of environmental sustainability criteria be chosen?

The sustainability is often separated into a social, economic and environmental sustainability. In this study only the environmental sustainability is included. Incorporating the social and economic sustainability would certainly affect the MSY and MSL. It would also be interesting how social and



economic sustainability criteria were defined and at which part of the systems diagram these criteria would apply.

From these 3 environmental systems only the biomass in a forest was a non linear system, whereby non linear systems has potential to do more research in. Also the system diagrams can easily be adjusted to make them more complicated as is suggested in chapter 4.5: major assumptions. Especially when the economic or social sustainability is included, then the system diagrams should be extended by introducing new flows and stocks. Furthermore, a way to measure the social and economic sustainability should be investigated. Every type of sustainability (social, economic and environmental ) would have its own MSY or MSL, for which the lowest MSY or MSL is the decisive criterion. Much greater variations between the MSY or MSL of different sustainability types are possible, which means that the environmental system is less efficient.

## 6. Conclusions

The statement that increasing the assimilative/regeneration capacity of an environmental system will increase the maximum sustainable load or yield is not always valid. This mainly depends on how the environmental sustainability criterion is defined and the characteristics of the environmental system. An investigation has been done with 2 fully stable linear systems and 1 partly stable non linear system. This investigation revealed that there are at least two exceptions to this statement. To determine if a system can be considered as an exception, the next characteristics are important: behavior of the system which can be constant linear or non linear, type and place of environmental sustainability criterion, the way of implementing variability in regeneration/assimilative capacity. For yield systems the natural inflow entity is assumed to represent the regeneration capacity and for waste system the natural outflow entity is assumed to represent the assimilative capacity.

The first exception is a stable, linear system that has a stock related absolute reduction criterion and the variability of the regeneration/assimilative capacity is represented as a shift of the systems behavior line, whereby the gradient is not changed. The shift of the behavior line may be caused by a shift in the inflow or outflow entity. A good example of this exception is the treated groundwater model in this study. The groundwater model consists of a constant recharge (inflow) and positive linear natural discharge (outflow). This results in a negative linear behavior line which indicates that the system is stable and linear. The environmental sustainability criterion is defined as a maximum groundwater level drawdown of 1 meter. Variation in regeneration capacity is represented as variation in the recharge. Variation in recharge will influence the equilibrium level of the groundwater aquifer and will shift the behavior line upwards or downwards. However the gradient of the behavior line is not changed so that a yield disturbance will deplete the aquifer at the same rate no matter what the value of recharge is. A maximum drawdown of 1 meter will therefore be violated at the same abstraction rate. The groundwater model meets the predefined characteristics of the first exception.

The second exception is a stable, linear system that has a stock related relative criterion, and the variability in the regeneration/assimilative capacity is represented as a change in the gradient of the systems behavior line, while no shift takes place. The change of the gradient of the behavior line should occur from the intersection with the y axis as is shown in Figure 63. A good example of this exception is the pollution in a lake model treated in this study. The pollution in a lake model consist of a constant natural inflow depending on discharge and background concentration and 2 positive linear outflows defined as the natural removal and natural outflow. This will result in a negative linear behavior line which indicates that the system is stable and linear. The environmental sustainability criterion is defined as relative criterion. Variation in the assimilative capacity is represented as variation in the removal rate. The natural removal is expressed as the removal rate multiplied by the value of the stock (total mass of pollution). The natural removal is therefore a positive linear line as a function of the stock value. Changes in the removal rate will change the gradient of the positive linear natural outflow line, while for every value of the removal rate the natural removal will be zero when the stock is zero. For variability in the assimilative capacity (removal rate) the behavior line will always intersect the y axis at the same point due to the dependence of the natural outflow on the stock value. This condition is necessary so that the exception is valid. The variability of the assimilative capacity will change the equilibrium amount of waste that is present in the system due to a change in the gradient of the behavior line. Therefore, a

relative sustainability criterion will also change the maximum tolerable increase of waste in the system. Higher assimilative capacities will have a steeper behavior line, wherefore the equilibrium is lower. The tolerable enlargement of waste in the system is thus lower due to the presence of a relative sustainability criterion. However, the behavior line is steeper and this will cause the system to better adapt to disturbances, since the disturbance will shift the behavior line upwards. These two phenomena will cancel each other out and the maximum sustainable load will be the same. The same thing will happen if the assimilative capacity is lower. The pollution in a lake model meets the predefined characteristics of the second exception.

The systems behavior is a combination of the distinguished characteristics inflow and outflow behavior, which will determine if the system is stable and indicates the level of nonlinearity. However, the form of disturbance (yield or waste) has no influence on supporting or contradicting the statement.

In non linear systems the statement is probably always valid. These non linear systems include every form of non linearity for which the gradient changes for different values of the stock. For example the behavior lines might be concave or convex. The variable gradient of the systems behavior line will always influence the MSY or MSL, since a shift of this behavior line will also lead to changes in the gradient. And if the gradient of the behavior line is only changed and the intersection of the behavior line with the y axis is also at the same point, then the two processes will not cancel each other out, because they probably do not have the same value because of the non linearity. However, only one nonlinear system was investigated to underpin this argument.

For flow related environmental sustainability criteria the statement may also not be valid. The system should have the same characteristics as described earlier for stock related environmental sustainability criteria. However the flow should be connected to the stock through a feedback loop and the way of implementation of the variability in regeneration/assimilative capacity should not occur at that specific flow.

Nonetheless, the statement will always be valid if the system has a fixed absolute criterion. A fixed absolute criterion contains a threshold that may not be violated. Variability in assimilative/regeneration capacity will always lead to a changed equilibrium value of the stock, leading to a change in the maximum tolerable reduction.

Although, defining an environmental sustainability criteria as a fixed absolute criteria is not general applicable. The equilibrium values of stocks and flows in environmental systems are different for different environmental systems around the world. Therefore a fixed absolute environmental sustainability criterion may indicate that the environmental system is already unsustainable in the initial state without human intervention.

## 7. References

- Acker, S. A., Boetsch, J. R., Bivin, M., Whiteaker, L., Cole, C., & Philippi, T. (2014). Recent tree mortality and recruitment in mature and old-growth forests in western Washington. *Forest Ecology and Management*, 336, 109–118. Retrieved from <http://linkinghub.elsevier.com/retrieve/pii/S0378112714005908>
- Angelstam, P., Breuss, M., & Mikusinski, G. (2001). Toward the Assessment of Forest Biodiversity at the Scale of Forest Management Units - a European Landscape Perspective. *EFI Proceedings*, 38(1), 59–74.
- Angelstam, P., & Törnblom, J. (2004). Maintaining Forest Biodiversity in Actual Landscapes - European gradients in history and governance systems as a Landscape Lab'. *EFI Proceedings*, 51(5), 299–313.
- Botkin, D. B., Janak, J. F., & Wallis, J. R. (1972). Some Ecological Consequences of a Computer Model of Forest Growth. *Journal of Ecology*, 60(3), 849–872.
- Bugmann, H. (2001). A REVIEW OF FOREST GAP MODELS. *Climate Change*, 51, 259–305.
- Bull, K. R. (1992). An introduction to critical loads. *Environmental Pollution*, 77, 173–176.
- Bütler, R., Angelstam, P., Ekelund, P., & Schlaepfer, R. (2004). Dead wood threshold values for the three-toed woodpecker presence in boreal and sub-Alpine forest. *Biological Conservation*, 119, 305–318. <http://doi.org/10.1016/j.biocon.2003.11.014>
- Chambers, J. Q., Higuchi, N., Schimel, J. P., Ferreira, L. V., & Melack, J. M. (2000). Decomposition and carbon cycling of dead trees in tropical forests of the central Amazon. *Oecologia*, 122, 380–388. <http://doi.org/10.1007/s004420050044>
- Chapra, S. T. (1997). *Surface water-quality modeling*. (B. J. Clark, D. A. Damstra, & J. W. Bradley, Eds.). McGraw-Hill Companies, New York, VS.
- Costanza, R., & Daly, H. E. (1992). Natural Capital and sustainable development. *Conservation Biology*, 6(1), 37–46.
- Cui, Y., & Shao, J. (2005). The Role of Ground Water in Arid / Semiarid Ecosystems , Northwest China. *Ground Water*, 43(4), 471–477.
- De Kok, J.-L., & Engelen, G. (2013). *Haalbaarheidsstudie systeemdynamische modellering en interactie thematische modellering Studie uitgevoerd in opdracht van de Vlaamse Milieumaatschappij*.
- Deaton, M. L., & Winebrake, J. J. (2000). *Dynamic modeling of environmental systems*. Springer-Verlag New York, inc.
- Downing, J. A., & Mccauley, E. (1992). The nitrogen : phosphorus relationship in lakes. *Limnology and Oceanography*, 37(5), 936–945.

- Effler, S. W., O'Donnell, S. M., Matthews, D. a., Matthews, C. M., O'Donnell, D. M., Auer, M. T., & Owens, E. M. (2002). Limnological and Loading Information and a Phosphorus Total Maximum Daily Load (TMDL) Analysis for Onondaga Lake. *Lake and Reservoir Management*, 18(2), 87–108.
- Forrester, J. W. (2007). System Dynamics Review; System dynamics - the next fifty years. *System Dynamics Review*, 23, 359–370. Retrieved from <http://dx.doi.org/10.1002/sdr.381>
- Garcia, S., Sparre, P., & Csirke, J. (1989). Estimating surplus production and maximum sustainable yield from biomass data when catch and effort time series are not available. *Fisheries Research*, 8, 13–23.
- Gleeson, T., Alley, W. M., Allen, D. M., Sophocleous, M. a., Zhou, Y., Taniguchi, M., & Vandersteen, J. (2012). Towards sustainable groundwater use: Setting long-term goals, backcasting, and managing adaptively. *Ground Water*, 50(1), 19–26.
- Goodland, R. (1995). The concept of environmental sustainability. *Annual Review of Ecology and Systematics*, 26(1995), 1–24. Retrieved from <http://www.jstor.org/stable/2097196>
- Hahn, K., & Christensen, M. (2004). Dead Wood in European Forest Reserves - A Reference for Forest Management. *EFI Proceedings*, 51(3), 181–191.
- Hao, X., Li, W., Huang, X., Zhu, C., & Ma, J. (2010). Assessment of the groundwater threshold of desert riparian forest vegetation along the middle and lower reaches of the Tarim River, China. *Hydrological Processes*, 24, 178–186. Retrieved from <http://jamsb.austms.org.au/courses/CSC2408/semester3/resources/ldp/abs-guide.pdf>
- Havens, K. E., & Schelske, C. L. (2001). The importance of considering biological processes when setting total maximum daily loads (TMDL) for phosphorus in shallow lakes and reservoirs. *Environmental Pollution*, 113, 1–9.
- Henriksen, H. J., Trolborg, L., Højberg, A. L., & Refsgaard, J. C. (2008). Assessment of exploitable groundwater resources of Denmark by use of ensemble resource indicators and a numerical groundwater-surface water model. *Journal of Hydrology*, 348, 224–240.
- Hoekstra, A. Y. (2013). *Dictaat Water*.
- Islam, M. J., Jang, C., Eum, J., Jung, S., Shin, M.-S., Lee, Y., ... Kim, B. (2013). The decomposition rates of organic phosphorus and organic nitrogen in river waters. *Journal of Freshwater Ecology*, 28(2), 239–250. Retrieved from <http://www.tandfonline.com/doi/abs/10.1080/02705060.2012.733969>
- Janse, J. H., De Senerpont Domis, L. N., Scheffer, M., Lijklema, L., Van Liere, L., Klinge, M., & Mooij, W. M. (2008). Critical phosphorus loading of different types of shallow lakes and the consequences for management estimated with the ecosystem model PCLake. *Limnologica*, 38, 203–219.
- Johnson, M. S., Billett, M. F., Dinsmore, K. J., Wallin, M., Dyson, K. E., & Jassal, R. S. (2010). Vegetation as affected by groundwater depth and microtopograpshy in a shallow aquifer area of the Great Basin. *Ecohydrology*, 5, 54–63. Retrieved from <http://www3.interscience.wiley.com/journal/122653919/abstract>

- Jonsson, B. G., Kruys, N., & Ranius, T. (2005). Ecology of species living on dead wood - Lessons for dead wood management. *Silva Fennica*, 39(2), 289–309.
- Kammesheidt, L., Kohler, P., & Huth, A. (2001). Sustainable timber harvesting in Venezuele: a modelling approach. *Journal of Applied Ecology*, 38, 756–770.
- Kar, T. K., & Ghosh, B. (2013). Impacts of maximum sustainable yield policy to prey–predator systems. *Ecological Modelling*, 250, 134–142. Retrieved from <http://linkinghub.elsevier.com/retrieve/pii/S0304380012005522>
- Karsenty, A., & Gourlet-Fleury, S. (2006). Assessing sustainability of logging practices in the Congo Basin's managed forests: The issue of commercial species recovery. *Ecology and Society*, 11(1), 26.
- Kumar, C. P., & Seethapathi, P. V. (2002). Assessment of natural groundwater recharge in Upper Ganga Canal command area. *Applied Hydrology*, 15(4), 13–20. Retrieved from [http://ndwr.state.nv.us/hearings/past/dry/browseable/exhibits\SNWA\Volume\\_6/285.pdf](http://ndwr.state.nv.us/hearings/past/dry/browseable/exhibits\SNWA\Volume_6/285.pdf)
- Lande, R., Sæther, B., & Engen, S. (1997). Threshold Harvesting for Sustainability of Fluctuating Resources, 78(5), 1341–1350.
- Lavigne, M., Nastev, M., & Lefebvre, R. (2010). Numerical Simulation of Groundwater Flow in the Chateaugay River Aquifers. *Canadian Water Resources*, 35(4), 469–486.
- Liere, E. Van, & Jonkers, D. a. (2002). *Watertypegerichte normstelling voor nutriënten in oppervlaktewater*. Bilthoven.
- McBride, A. C., Dale, V. H., Baskaran, L. M., Downing, M. E., Eaton, L. M., Efroymson, R. a., ... Storey, J. M. (2011). Indicators to support environmental sustainability of bioenergy systems. *Ecological Indicators*, 11(5), 1277–1289. Retrieved from <http://dx.doi.org/10.1016/j.ecolind.2011.01.010>
- Mccarthy, J. J., Wynne, D., & Berman, T. (1982). The uptake of dissolved nitrogenous nutrients by Lake Kinneret (Israel) microplankton. *Limnology and Oceanography*, 27(4), 673–680.
- Meadows, D. H. (2008). *Thinking in systems A primer*. (Diana Wright (Sustainability institute), Ed.). Chelsea Green Publishing.
- Müller, J., & Büttler, R. (2010). A review of habitat thresholds for dead wood: A baseline for management recommendations in European forests. *European Journal of Forest Research*, 129, 981–992.
- Pretzsch, H. (2010). *Forest Dynamics, Growth and Yield*. Springer. Springer-Verlag Berlin Heidelberg. Retrieved from <http://link.springer.com/10.1007/978-3-540-88307-4>
- Radu, S. (2006). The ecological role of deadwood in natural forests. In D. Gafta & J. Akeroyd (Eds.), *Nature Conservation: Concepts and Practice* (pp. 137–141). Springer-Verlag Berlin Heidelberg.
- Richter, B. D., Davis, M. M., Apse, C., & Konrad, C. (2011). A presumptive standard for environmental flow protection. *River Research and Applications*, 28, 1312–1321.

- Swaine, M. D., Lieberman, D., & Putz, F. E. (1987). The dynamics of tree populations in tropical forest: a review. *Journal of Tropical Ecology*, 3(4), 359–366.
- Tobin, B., Black, K., McGurdy, L., & Nieuwenhuis, M. (2007). Estimates of decay rates of components of coarse woody debris in thinned Sitka spruce forests. *Forestry*, 80(4), 455–469.  
<http://doi.org/10.1093/forestry/cpm024>
- Voorn, G. A. K. van. (2012). *Tipping points in natural systems An inventory of types , early warnings , and consequences*. Wageningen.
- Walker, W. W. (2000). *Estimation of a Phosphorus TMDL for Lake Okeechobee*.
- Wilensky, U. (1999). *Cener for Connected learning and computer-based modeling*. Retrieved from <http://ccl.northwestern.edu/netlogo/>
- IPCC, 2014: Summary for policymakers. In: Climate Change 2014: Impacts, Adaptation, and Vulnerability. Part A: Global and Sectoral Aspects. Contribution of Working Group II to the Fifth Assessment Report of the Intergovernmental Panel on Climate Change [Field, C.B., V.R. Barros, D.J. Dokken, K.J. Mach, M.D. Mastrandrea, T.E. Bilir, M. Chatterjee, K.L. Ebi, Y.O. Estrada, R.C. Genova, B. Girma, E.S. Kissel, A.N. Levy, S. MacCracken, P.R. Mastrandrea, and L.L. White (eds.)]. Cambridge University Press, Cambridge, United Kingdom and New York, NY, USA, pp. 1-32.
- Besluit kwaliteitseisen en monitoring water (2009)
- <http://www.systemdynamics.org/what-is-s/> ; visited on May 6, 2015
- <https://stats.oecd.org/glossary/detail.asp?ID=479> visited on April 10, 2015

## Appendix I: Netlogo codes

The codes that are used to model the environmental systems in this research are shown below:

### Groundwater model

#### Interface:

Add button: Setup and go

Add slider: ini-level, ini-level-river, H, R, Beta, Surface\_Area, bottom\_aquifer, k

Add plot 1: plot level, plot level-river

Add plot 2: plot Q

Add Monitor: level, Q

#### Code:

```
globals [level level-river S Q respons I]
```

```
to setup
  clear-all
  set level ini-level
  set level-river ini-level-river
  set S ((level - bottom_aquifer) * Surface_Area)
  set respons ((k / S) ^ (1 / Beta)) * (S)
  set Q (S / respons) ^ (Beta)
  reset-ticks
end
```

```
to go
  if ticks > 2400 [stop]
  Recharge
  Discharge_to_river
  pumping-water
  tick
  calculation
end
```

```
to Recharge
  set I ((R / 12000) * Surface_Area )
end
```

```
to Discharge_to_river
  set Q (S / respons) ^ (Beta)
end
```

```
to pumping-water
  set H H
end
```



```
to calculation
  set S S + (I - Q - H)
  set level (S / Surface_Area) + bottom_aquifer
end
```

**Biomass in a forest model:**Interface:

Add button: Setup and go

Add slider: ini-wood, ini-dead-wood, A, m, r, K, k1

Add plot 1: plot S

Add plot 2: plot W

Add Monitor: S, W

Code:

```
globals[S W G D U]
```

```
to setup
  clear-all
  set S ini_wood
  set W ini-dead-wood
  reset-ticks
end
```

```
to go
  fertility
  mortality
  logging
  natural_removal
  calculation
  tick
  if ticks >= 750 [stop]
end
```

```
to fertility
  set G (r * S * (1 - (S / K)))
end
```

```
to mortality
  set D (m * S)
end
```

```
to logging
  set A A
end
```

```
to natural_removal
  set U ( k1 * W)
end
```

```
to calculation
  set S S + (G - D - A)
  set W W + (D - U)
end
```

### **Pollution in a lake model:**

#### Interface:

Add button: Setup and go

Add slider: Ini-N, Ini-P, cinN, cinP, d, A, k, Q, RatioNP, cin, De

Add Plot: plot (N+P), plot P, plot N

Add monitor: N+P, N, P, N/P

#### Code:

globals [P N M Ip In Op On Ap An Dp Dn]

```
to setup
  clear-all
  set P ini-P
  set N ini-N
  set Q Q
  reset-ticks
  set cinN (cin / 13)* 12
  set cinP (cin / 13)
end
```

```
to go
  Inflow
  Outflow
  Assimilation
  Load
  calculation
  tick
  if ticks >= 365 [stop]
end
```

```
to Inflow
  set Ip (Q * cinP)
  set In (Q * cinN)
end
```

to Outflow

```
set Op (Q * ( P / (A * d)))  
set On (Q * ( N / (A * d)))  
end
```

to Assimilation

```
set Ap (k * P)  
set An (k * N)  
end
```

To Load

```
set Dn ((De / (RatioNP + 1)) * RatioNP)  
set Dp ( De / (RatioNP + 1))  
end
```

to calculation

```
set N N + (In + Dn - An - On)  
set P P + (Ip + Dp - Ap - Op)  
end
```